



Telangana State Board of
INTERMEDIATE Education
FIRST YEAR

BASIC LEARNING MATERIAL
For The Academic Year : 2021-2022

CHEMISTRY-I





**TELANGANA STATE BOARD OF
INTERMEDIATE EDUCATION**

CHEMISTRY

**FIRST YEAR
(English Medium)**

BASIC LEARNING MATERIAL

**ACADEMIC YEAR
2021-2022**

Coordinating Committee

Sri Syed Omer Jaleel, IAS

Commissioner, Intermediate Education &
Secretary, Telangana State Board of Intermediate Education
Hyderabad

Dr. Md. Abdul Khaliq

Controller of Examinations
Telangana State Board of Intermediate Education

Educational Research and Training Wing

Ramana Rao Vudithyala

Reader

Mahendar Kumar Taduri

Assistant Professor

Vasundhara Devi Kanjarla

Assistant Professor

Learning Material Contributors

K. Srikanthrao

JL in Chemistry, Pragati Mahavidyalaya Jr. College,
Hanuman Tekdi, Koti, Hyderabad

S. Mary Sujatha

JL in Chemistry, Nrupatunga Jr. College,
Hyderabad

T. Narmatha Singh

JL in Chemistry, Govt. Jr. College,
Old Malakpet, Hyderabad

PREFACE

The ongoing Global Pandemic Covid-19 that has engulfed the entire world has changed every sphere of our life. Education, of course is not an exception. In the absence of Physical Classroom Teaching, Department of Intermediate Education Telangana has successfully engaged the students and imparted education through TV lessons. In the back drop of the unprecedented situation due to the pandemic TSBIE has reduced the burden of curriculum load by considering only 70% syllabus for class room instruction as well as for the forthcoming Intermediate Examinations. It has also increased the choice of questions in the examination pattern for the convenience of the students.

To cope up with exam fear and stress and to prepare the students for annual exams in such a short span of time , TSBIE has prepared “Basic Learning Material” that serves as a primer for the students to face the examinations confidently. It must be noted here that, the Learning Material is not comprehensive and can never substitute the Textbook. At most it gives guidance as to how the students should include the essential steps in their answers and build upon them. I wish you to utilize the Basic Learning Material after you have thoroughly gone through the Text Book so that it may enable you to reinforce the concepts that you have learnt from the Textbook and Teachers. I appreciate ERTW Team, Subject Experts, who have involved day in and out to come out with the, Basic Learning Material in such a short span of time.

I would appreciate the feedback from all the stake holders for enriching the learning material and making it cent percent error free in all aspects.

The material can also be accessed through our website www.tsbie.cgg.gov.in.

Commissioner & Secretary
Intermediate Education, Telangana.

CONTENTS

Unit 1	Atomic Structure	1
Unit 2	Classification of elements and Periodicity in Properties	7
Unit 3	Chemical Bonding and Molecular Structure	13
Unit 4	States of Matter	23
Unit 5	Stoichiometry	29
Unit 6	Thermo Dynamics	35
Unit 7	Chemical Equilibrium and Acids - Bases	39
Unit 8	Hydrogen and its Compounds	44
Unit 9	s-Block Elements	47
Unit 10	p-Block Elements - Group 13	50
Unit 11	p-Block Elements - Group 14	52
Unit 12	--	--
Unit 13	Organic Chemistry - Hydrocarbon and Aromatic Hydrocarbon	55

Atomic Structure

Very Short Answer Type Questions (2 Marks)

1. What is a black body?

Ans. The ideal body which emits and absorbs radiations of all frequencies is called a black body. The radiation emitted by such a body is called black body radiation. A hollow sphere coated inside with a platinum black, which has a small hole in its wall can act as a black body.

2. How many p electrons are present in sulphur atom?

Ans. Electronic configuration of sulphur = $1s^2 2s^2 2p^6 3s^2 3p^4$
 \therefore Number of p electrons present in sulphur atom = 10.

3. What is the frequency of radiation of wave length 600nm?

Ans. Wave length $\lambda = 600\text{nm} = 600 \times 10^{-7} \text{ cm} = 6 \times 10^{-5} \text{ cm}$
 Velocity of light $c = 3 \times 10^{10} \text{ cm/sec}$.

$$\text{Frequency } \nu = \frac{c}{\lambda} = \frac{3 \times 10^{10}}{6 \times 10^{-5}} = 5 \times 10^{14} \text{ sec}^{-1}.$$

4. What is Zeeman effect?

Ans. The splitting of one spectral line of an atom into several fine lines in the presence of strong magnetic field is called Zeeman effect.

5. What is the Stark effect?

Ans. The splitting of one spectral line into several fine lines in the presence of strong electric field is called Stark effect.

6. Explain Pauli's exclusion principle?

Ans. **Pauli's exclusion principle:** No two electrons in an atom can have the same set of four quantum numbers.

Eg: He : $Z = 2$

e^-	n	l	m_l	m_s
1st	1	0	0	$+\frac{1}{2}$
2nd	1	0	0	$-\frac{1}{2}$

7. What is Aufbau Principle?

Ans. In the ground state of the atoms, the orbitals are filled in order of their increasing energies. The order in which the orbitals are filled as follows:

$$1s < 2s < 2p < 3s < 3p < 4s < 3d < 4p < 5s$$

8. What is Hund's Rule?

Ans. Electron pairing will take place after all the available degenerate orbitals are filled with one electron each (Or)

Pairing of electrons in the degenerate orbitals to place, when each orbital is filled with one electron.

9. Explain Heisenberg's uncertainty principle.

Ans. It is impossible to determine simultaneously, the exact position and exact momentum (or Velocity) of an electron. Mathematically, it can be given as an equation:

$$\Delta X \cdot \Delta P \geq \frac{h}{4\pi}$$

Where

ΔX = Uncertainty in position

ΔP = Uncertainty in momentum

h = Planck's Constant

Short Answer Type Questions - 4 Marks**1. What is a nodal plane? How many nodal planes are possible for 2p and 3d orbitals?**

Ans. The plane passing through the nucleus at which probability of finding an electron is Zero. This is called a nodal plane.

Number of nodal planes in any orbital = l (Azimuthal Quantum number)

For 2p orbital, no. of Nodal Planes = 1

For 3d orbital, no. of Nodal Planes = 2

2. Explain the difference between emission and absorption spectra.

Ans.	Emission Spectrum	Absorption Spectrum
1.	Emission spectrum is obtained when radiation from the source are directly analysed in the spectroscope.	1. Absorption spectrum is obtained when the white light is first passed through the substance and the transmitted light is analysed in the spectroscope.
2.	It is formed due to emission of energy in quanta.	2. It is formed due to absorption of energy in quanta.
3.	It consists bright coloured lines on dark background.	3. It consists of dark coloured lines on bright background.
4.	This spectrum can be continuous or discontinuous.	4. This spectrum is always discontinuous.

3. Explain the difference between orbit and orbital?

Ans.	Orbit	Orbital
1.	An orbit is a well defined circular path around the nucleus in which the electron revolve	1. An orbital is the three dimensional space around the nucleus in which the probability of finding the electron is maximum.
2.	It represents planar motion of an electron around the nucleus.	2. It represents the three dimensional motion of an electron around the nucleus.
3.	Orbits can be circular or elliptical shaped.	3. Orbitals have different shapes eg. S-Orbital is spherical P-Orbital is dumbbell shaped.
4.	An orbit can have a maximum number of electrons equal to $2n^2$.	4. An orbital can accomodate a maximum two electrons.

4. Explain Photoelectric effect?

Ans. Where a beam of light of sufficiently high frequency is allowed to strike a clean metal surface, electrons are ejected from the metal surface. This phenomenon is known as Photoelectric effect and ejected electrons are known as Photoelectrons.

Metals like Potassium, Rubidium, Caesium etc exhibit this effect.

The number of electrons ejected is proportional to the intensity of incident light.

The Kinetic Energy of ejected electrons is directly proportional to the frequency of incident light.

A certain minimum frequency which can just cause the ejection of electron is called threshold frequency (ν_0).

The striking Photon has energy equal to $h\nu$ and minimum energy required to eject the electron is $h\nu_0$ also called as work function w_0 , then the difference is energy ($h\nu - h\nu_0$) is transferred into kinetic energy of the Photoelectron.

$$h\nu = w_0 + KE$$

$$h\nu = h\nu_0 + \frac{1}{2} m_e V^2$$

Einstein was able to explain the photoelectric effect using Planck's quantum theory of electromagnetic radiation.

Long Answer Questions (8 Marks)

1. What are the postulates of Bohr's model of hydrogen atom? Discuss the importance of this model to explain various series of line spectra in hydrogen atom. Write the Limitations of Bohr's model.

Ans: 1. The electrons in an atom revolve around the nucleus in certain fixed circular paths called orbits or energy levels or shells.

2. A certain fixed amount of energy is associated with each electron in a particular orbit. So the orbits are also called as energy levels. The energy levels are numbered as 1, 2, 3, 4 and also designated by letters K, L, M, N respectively.
3. As long as electron revolves around the nucleus in an orbit, the energy of electron remains constant. Hence these orbits are called Stationary Orbits.
4. The orbit near to nucleus will have low energy and the orbit away from nucleus will have high energy.
5. Energy is emitted when an electron jumps from higher energy level to lower energy level.

$$\Delta E = E_2 - E_1 \quad E_2 = \text{Higher energy level} \quad E_1 = \text{Lower energy level}$$

$$v = \frac{\Delta E}{h} = \frac{E_2 - E_1}{h} \quad h = \text{Planck's Constant} = 6.625 \times 10^{-27} \text{ erg.sec}$$

Where E_1 and E_2 are energies of the lower and higher allowed energy states

6. The angular momentum of an electron moving around the nucleus is quantised. The angular momentum is an integral multiple of $\frac{h}{2\pi}$

$$\text{i.e., } mvr = \frac{nh}{2\pi} \quad m = \text{Mass of Electron} \quad v = \text{Velocity of Electron}$$

$$r = \text{Radius of Orbit} \quad n = 1, 2, 3, 4, \dots$$

$$h = \text{Planck's Constant} = 6.625 \times 10^{-27} \text{ erg.sec}$$

Explanation of Hydrogen Spectrum

Hydrogen atom contains only one electron and shows many lines in the spectrum. When hydrogen gas is subjected to electric discharge, hydrogen molecules absorb energy and split into atoms.

The electrons in atoms absorb energy and will get excited and come back to their ground state and emit radiations of different frequencies. So we can show these series of lines observed in hydrogen spectrum in the table given below

The Spectrum line for Atomic Hydrogen

Series	n_1	n_2	Spectral Region
Lyman	1	2,3,4,....	Ultra Violet
Balmer	2	3,4,5,....	Visible
Paschen	3	4,5,6,....	Infrared
Brackett	4	5,6,7,....	Infrared
Pfund	5	6,7,8,....	Infrared

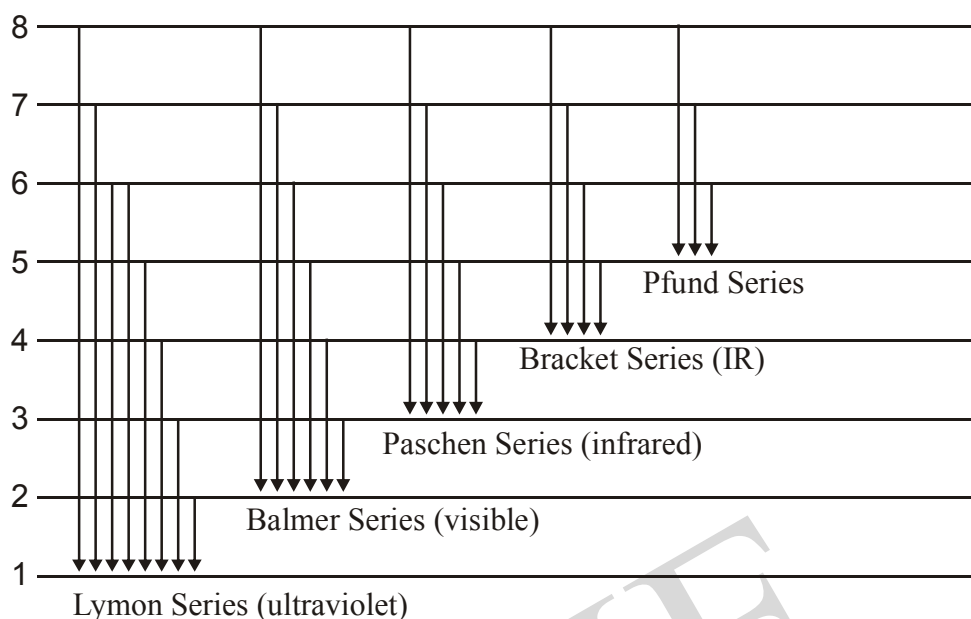

Limitations of Bohr's Model of an atom

1. Bohr's Model of an atom could explain the spectrum of single electron species (H, He^+ , Li^{+2} etc) but not the spectra of multielectron species.
2. Failed to explain Zeeman and Stark effects.
3. Cannot explain fine structure in the atomic spectra.
4. Cannot explain the formation of chemical bonds.
5. It failed to explain the dual nature of electrons.

2. How are the quantum numbers n , l , m_l arrived at? Explain the significance of these quantum numbers.

Ans: To explain the size of the orbit, energy of electron, shape of orbital, orientation and spin of electron four quantum numbers are predicted. They are

1. Principal quantum number (n)
2. Azimuthal quantum number (l)
3. Magnetic quantum number (m_l)
4. Spin quantum number (m_s)

1) Principal Quantum number (n)

- a) This was proposed by Neils Bohr.
- b) It is denoted by the letter 'n' and given the values 1, 2, 3, 4.
- c) It represents orbits or shells around the nucleus and its size and energy.
- d) As the value of n increases the size and energy of orbit increases.
- e) In any orbit number of orbitals are given by n^2 and number of electrons by $2n^2$.

2) Azimuthal Quantum

- This was proposed by Sommerfeld.
- It is denoted by letter "l".
- It represents the sub-levels present in the main levels and can have the values 0 to (n-1)
- The number of subshells in the main shell is equal to 'n'.

n	l
1	0
2	0, 1
3	0, 1, 2

- It described the shape of the orbitals

l	Orbital	Shape of the Orbit
0	s - Orbital	Spherical
1	p - Orbital	dumbbell
2	d - Orbital	double dumbbell
3	f - Orbital	fourfold dumbbell

3. Magnetic Quantum number (m_l)

- This was proposed by Lande.
- It is denoted by ' m_l '.
- It described the orbitals present in a given subshell and can have the values $-l$ to $+l$ through zero.

Sublevel	l value	m values	No. of Orbitals
s	0	0	1
p	1	-1, 0, +1	3
d	2	-2, -1, 0, +1, +2	5
f	3	-3, -2, -1, 0, +1, +2, +3	7

- These quantum numbers describe the orientation of orbitals in space and explain Zeeman and Stark effects.

4. Spin Quantum number: m_s

- It was proposed by Uhlenbeck and Goudsmit.
- It is denoted by m_s .
- This quantum number describes the spin of the electrons.

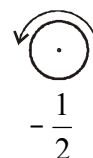
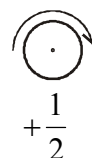

- m_s value of clockwise electron is $+\frac{1}{2}$ and that of anticlockwise electron is $-\frac{1}{2}$.

Classification of elements and Periodicity in Properties

Very Short Answer Type Questions (2 Marks)

1. **What are the representative elements? Give their valence shell configuration.**

Ans. S and P block elements excluding O group are called representative elements.

The valence shell configuration is $ns^{1-2} np^{0-5}$

2. **What factors impart characteristic properties to the transition elements?**

Ans. The Vacant or partially filled d- orbital of penultimate shell small size, high nuclear charge impart characteristic properties to the transition elements.

3. **IE of O is less than that of N - explain.**

Ans. Nitrogen has stable half filled P configuration. So more amount of energy is required to remove an electron from nitrogen than in oxygen. So IE of nitrogen is greater than that of oxygen.

4. **What is screening effect? How is it related to IE?**

Ans. The inner shell electrons screen the outer shell electrons from the attractions of the nucleus. This is called screening effect of shielding effect.

$$IE \propto \frac{1}{\text{screening effect}}$$

5. **Why the Zero group elements are called noble gases or inert gases?**

Ans. These contain stable octet configuration. So they are chemically inactive due to completely filled orbitals in the outer shell $ns^2 np^6$ (He- $1s^2$). Hence these are called noble gases.

6. **Na^+ has higher value of ionization energy than Ne, though both have same electronic configuration - explain.**

Ans: Effective nuclear charge is more in Na^+ than in Ne. So ionization energy of Na^+ is more than Ne.

7. Electron affinity of chlorine is more than that of fluorine - explain

Ans: Fluorine has small size. More electronic repulsions exist in Fluorine. So electron affinity of chlorine is more than that of Fluorine.

8. What are rare earths and transuranic elements?

Ans: The elements in which differentiating electrons enter into 4f orbitals are called rare earths or lanthanoids. The elements after Uranium are called Transuranic elements and these elements are man made. All are radio active elements.

Short Answer Type Questions (4 Marks)**1. Give any characteristic properties of transition elements.**

Ans: a) They are hard and heavy metals.
 b) They have high melting points, boiling points and densities.
 c) They are good conductors of heat and electricity
 d) They are good catalysts.
 e) They form alloys.
 f) They exhibit variable oxidation states.

2. What is diagonal relationship? Give a pair of elements having diagonal relationship. Why do they show relation?

Ans: In the periodic table, an element of a group in the second period is similar in properties with second element of next group in the third period. This type of relationship is called diagonal relationship.

eg: (a) Li-Mg (b) Be-Al (c) B -Si

Group	I_A		II_A		III_A		IV_A
2nd Period	Li	↘	Be	↘	B	↘	C
3rd Period	Na		Mg		Al		Si

The diagonal relationship is due to

- (a) Similar size of atoms or ions
- (b) Similar Electro negativity
- (c) Same polarizing power,

Where

$$\text{Polarising power} = \frac{\text{Ionic charge}}{\text{Ionic radius}}$$

3. What is lanthanide contraction? What are its consequences?

Ans: **Lanthanide Contraction** : The steady decrease of atomic or ionic radii from left to right in lanthanides is called lanthanide contraction.

It is due to poor shielding effect and peculiar shapes of f-orbitals.

Consequences:

- (1) The properties of elements are similar. Therefore it is difficult to separate them from the mixture.
- (2) The atomic radii of 5d and 4d transition elements are very close to each other when compared to those of 3d and 4d transition elements.

Long Answer Type Questions (8 Marks)**1. Write an essay on S, P, D and F block elements.**

Ans: Based on electronic configuration, elements are classified into four blocks.

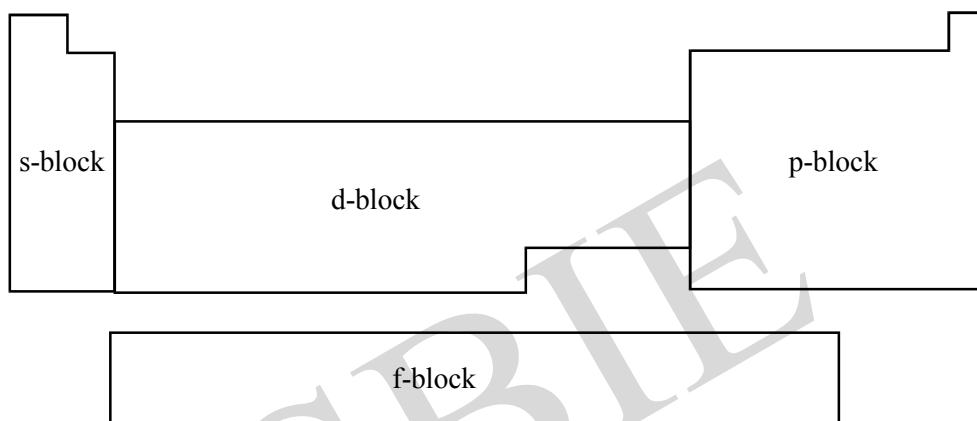

They are

s-Block elements

- The elements in which the differentiating electron enters into outer most 's' sub shell is called S block elements.
- The position of 's' block elements is on the left side of the periodic table.
- 's' block contains two groups IA and IIA. These elements are called alkali metals alkaline earth metals.
- The general electronic configuration of IA group of elements is ns^1 and IIA group elements is ns^2 .
- These are highly reactive elements and strongly electropositive in nature due to low ionization enthalpy
- They do not occur free in state in nature, but occur as their compounds.
- They form +1 (IA) and +2 (IIA) oxidation states. These are metallic in nature.

p-block elements

- The elements in which the differentiating electron enters into 'p' sub shell are called 'p' block elements.
- The position of 'p' block elements is on the right hand side of the periodic table

- (c) 'p' block elements contain III_A to VII_A and O groups.
- (d) The general electronic configuration is ns^2np^{1-6} .
- (e) p-block elements contain non metals, metalloids and metals.

d-block elements

- (a) The elements in which differentiating electron enters into penultimate (n-1)d sub shell are called d-block elements.
- (b) The Position of d-block elements is in between s-block elements and p-block elements. They are known as transition elements.
- (c) The elements of IIIB to VIIB, VII, IB, IIB are d-block elements.
- (d) The general configuration of these elements is $(n-1)d^{1-10}ns^{1-2}$.
- (e) Based on the filling of the differentiating electron d Block is divided into 3d, 4d, 5d series contains 10 elements and 6d series is incomplete.

f-block elements

- (a) The elements in which differentiating electron enters into anti penultimate (n-2)f sub shell are called f block elements.
- (b) The f block elements are placed in the bottom of the periodic table.
- (c) f block elements contain two series 4f and 5f. Each series contains 14 elements.
- (d) The general electronic configuration is $(n-2)f^{1-14} (n-1)d^{0-1} ns^2$.
- (e) These are known as inner transition elements. They are radio active in nature.

2. What is a periodic property? How the following properties vary in a group and in a period? Explain :

- (a) Atomic radius
- (b) ionisation enthalpy
- (c) Electron gain enthalpy
- (d) Electro negativity

Ans: The repetition of properties of elements at regular intervals in the periodic table are called as periodic properties and the phenomenon is called periodicity.

- (a) **Atomic radius:** The distance between the centre of the nucleus and the outermost shell of an atom is called its atomic radius.

In a group: Atomic radius in a group from top to bottom increases, because in every group, the differentiating electron enters into a new shell.

In a period: Atomic size decreases from left to right in a period, because the effective nuclear charge increases as the differentiating electron enters into the same shell.

- (b) **Ionisation enthalpy:** The energy required to remove an electron from an isolated gaseous atom in its ground state is called ionisation enthalpy.

In a group: As atomic size increases in a group from top to bottom, the screening effect

increases. The nuclear attraction over valency electrons decreases and as a result IE decreases down the group.

In a period: The atomic size decreases from left to right in a period, so the effective nuclear charge increases and nuclear attraction on valence electrons increases as a result I.E increases.

(C) Electron gain Enthalpy: The amount of energy released when an electron is added to the valence shell of neutral gaseous atom is called electron gain enthalpy.

In a group: As we go down the group atomic size increases as a result the attraction between added electron and nucleus decreases. Hence Electron gain Enthalpy decreases in a group.

In a period: As we go from left to right in a period atomic size decreases. As a result, the attraction between the added electron and nucleus increases. Hence electron gain enthalpy increases in a period.

(D) Electro negativity: the tendency of an atom to attract the shared pair of electrons towards itself is called electronegativity.

In a group: As we go down top to bottom in a group atomic size increases as a result of which the tendency of attraction of nucleus on shared pair decreases. Hence electro negativity decreases in a group.

In a period: As we go from left to right in a period, atomic size decreases as a result of which the tendency of attraction of nucleus on shared pair increases. Hence electro negativity increases in a period.

3. **Define IE_1 and IE_2 . Why is IE_2 is greater than IE_1 for a given atom. Discuss the factors that effect the IE of an element.**

Ans. **IE_1 :** The minimum energy required to remove the most loosely bounded electron from an isolated gaseous atom is called as first Ionisation Enthalpy.

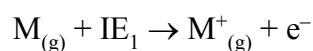

IE_2 : The energy required to remove an electron from uni positive gaseous ion is called as second Ionisation Enthalpy IE_2 .

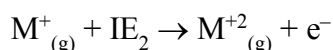

$IE_2 > IE_1$: The second Ionization enthalpy is greater than first ionization enthalpy on removing the electron from an atom. The unipositive ion is formed in that ion effective nuclear charge increases ie the nuclear attraction increases on the remaining electrons. Therefore more energy is required to remove an electron from uni positive ion.



Factors influencing the ionization enthalpy:

1. **Atomic radius:** As the atomic radius increases, the nuclear force of attraction over the valence electrons decreases so IE is less.

$$IE \propto \frac{1}{\text{Atomic radius}}$$

2. **Nuclear charge:** As the nuclear charge increases the force of attraction on the valence electrons increases. Hence IE is more.

$$IE \propto \text{Nuclear charge}$$

3. **Screening effect or shielding effect:** The electrons present in inner orbitals decreases the nuclear attraction on the valence electrons. This is called screening or shielding effect. As the number of electrons in the inner shells increases, shielding effect increases. So IE is less.

$$\text{Ionisation enthalpy} \propto \frac{1}{\text{screening effect}}$$

4. **Extent of penetration of orbitals of valence electrons:**

- (a) Penetration Power of orbitals depends on the shape of the orbitals.
- (b) Penetration power of orbitals is in the order : $s > p > d > f$

5. **Half filled or completely filled sub shells:** Atoms with half filled or completely filled sub shells are more stable. So IE values of these atoms are high.

Chemical Bonding and Molecular Structure

Very Short Answer Type Questions (2 Marks)

1. What is Octet rule?

Ans. Atoms prefer to have eight electrons in their outermost orbits by losing, gaining or sharing electrons, in order to have an Octet in their valence shell. This is known as Octet rule.

2. Write Lewis dot structures for S and S²⁻.

Ans. The Lewis dot structure are:

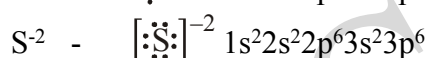

3. Predict the change if any, in hybridization of Al atom in the following reaction:



Ans. In AlCl_3 , Al undergoes sp^2 hybridization and the shape of the molecule is trigonal planar. In AlCl_4^- & Al undergoes sp^3 hybridization and the shape of the ion is tetrahedral.

4. Which of the two ions Ca⁺² or Zn⁺² is more stable and why?

Ans. Ca^{+2} is more stable than Zn^{+2} because Ca^{+2} has Octet configuration in valence shell, whereas Zn^{+2} has pseudo Octet configuration in valence shell.



5. Cl⁻ ion is more stable than Cl atom. Why?

Ans: Cl^- - possess $3s^2 3p^6$ stable Octet configuration.

Cl - possess $3s^2 3p^5$ does not have Octet configuration.

6. Why argon does not form Ar₂ molecule?

Ans: Argon is monoatomic gas as it possess stable Octet configuration in its valence shell. $3s^2 3p^6$. It cannot share its electron with another Ar atom and does not form diatomic molecule.

7. How many Sigma and Pi bonds are present in (a) C_2H_2 , (b) C_2H_4 ?

Ans: In C_2H_2 $[H-C \equiv C-H]$ 3 Sigma bonds and 2 Pi bonds are present.

In C_2H_4 $[H-\overset{\overset{H}{|}}{C}=\overset{\overset{H}{|}}{C}-H]$ 5 Sigma bonds and 1 Pi bond is present.

8. Is there any change in the hybridization of Boron and Nitrogen atom as a result of the following reaction: $BF_3 + NH_3 \rightarrow F_3BNH_3$

Ans: Before the reaction in the hybridization of Boron is sp^2 and after the reaction it is sp^3 . But for Nitrogen it is sp^3 before and after the reaction.

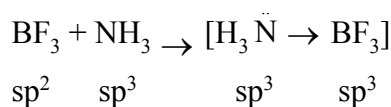

9. Write the possible resonance structures for SO_3 ?

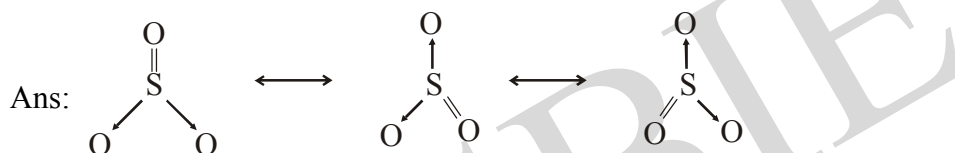

Short Answer Type Questions (4 Marks)

1. Define Dipole moment. Write its applications?

Ans: Dipole moment can be defined as the product of the magnitude of the charge and the distance between the charges. It is denoted by μ

$$\mu = Q \times l \qquad Q = \text{Charge on dipole}$$

$$\mu = \text{Charge} \times \text{distance between the charges} \quad l = \text{distance between the dipoles.}$$

It is expressed in Debye units or coulomb meter

$$\text{Debye unit} = 3.33 \times 10^{-30} \text{ cm}$$

Applications:

1. It is used to decide the polarity of the molecules. Molecules with zero dipole moment are non-polar and those with dipole moment are polar.
2. It is used to fixed geometry of molecule.

2. What are σ and π bonds? Specify the difference between them?

Ans: **Sigma Bond (σ):** A covalent bond formed by the end to end (head on) overlap of bonding orbitals along with internuclear axis. This is called as head on overlap or axial overlap.

Pi Bond (π): A covalent bond formed by a sidewise overlap or lateral overlap is called Pi bond.

Differences between Sigma bond and Pi bond

Sigma Bond (σ)	Pi Bond (π)
1. Sigma bond is formed by end to end (head on) overlap of bonding orbitals along the internucleus axis.	1. Pi bond is formed by parallel or lateral overlap of a bonding orbitals perpendicular to the internucleus axis.
2. It is a strong bond.	2. It is a weak bond.
3. It allows free rotation of atoms or groups about the bond.	3. Pi bond restricts free rotation.
4. It can exist independently.	4. it is formed only after the ' σ ' bond is formed.
5. Hybrid orbitals forms only σ bonds.	5. Hybrid Orbitals cannot form π bonds.

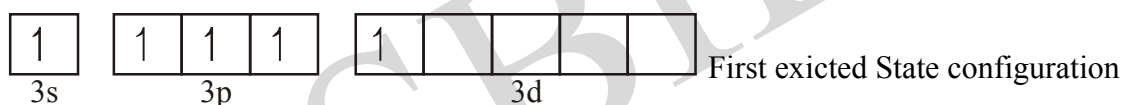
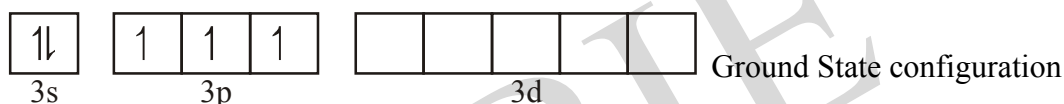
3. Explain the hybridization involved in PCl_5 molecule?Ans: PCl_5 - Phosphorous PentachlorideP - 15 $3s^2 3p^3$ 

- Phosphorous is PCl_5 molecule undergoes sp^3d hybridisation.
- One 's' and three 'p' and one 'd' orbitals of phosphorous atom undergo sp^3d hybridization gives 5 sp^3d hybrid orbitals of equal energy.
- These hybrid orbitals overlap with singly occupied p-orbitals of chlorine atoms to form 5 P-Cl sigma bonds.
- PCl_5 is having trigonal bipyramidal shape with bond angles 90° to 120° .

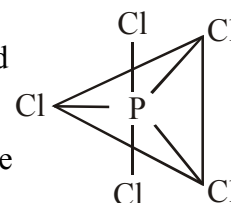
4. Explain the hybridization involved in SF_6 molecule.Ans: SF_6 - Sulphur hexafluoride

S - 16

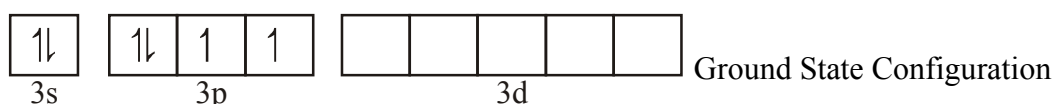

1. Sulphur in SF_6 molecule undergoes sp^3d^2 hybridization.

2. One 's' and three 'p' and two 'd' orbitals of Sulphur atom undergoes sp^3d^2 hybridization.

3. These 6 hybrid sp^3d^2 orbitals overlap with 6 singly occupied p - orbitals of fluorine atoms to form 6 sp^3d^2 - p sigma bonds.

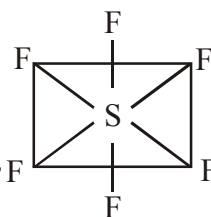

4. SF_6 is having regular Octahedral shape.

5. Bond angle is 90° , 180° .

5. Explain the formation of coordinate covalent bond with one example.

Ans: 1) The covalent bond formed in which the shared pair of electrons is contributed by one atom only.

2) The atom which donates the shared pair of electrons is called as donor and that which accepts the electrons is called as acceptor.

3) The bond between two atoms in which one donates a pair of electrons and other accepts a pair of electrons is called as coordinate covalent bond or dative bond.

eg: Formation of NH_4^+

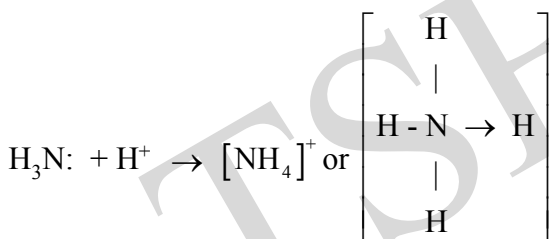

donor acceptor ammonium ion

Coordinate covalent bond is shown by arrow which is directed from donor to acceptor.

6. What is Hydrogen bond? Explain the different types of Hydrogen bonds with example.

Ans: Hydrogen bond is defined as the electrostatic forces of attraction between a partially positively charged hydrogen atom in the molecule and negatively charged electronegative atom of the same molecule or another molecule.

There are two types of hydrogen bond. They are:

1) Inter molecular Hydrogen bond

2) Intra molecular Hydrogen bond.

1. Intermolecular Hydrogen bond: It is formed between two different molecules of the same or different compounds.

Example: H - F molecule.

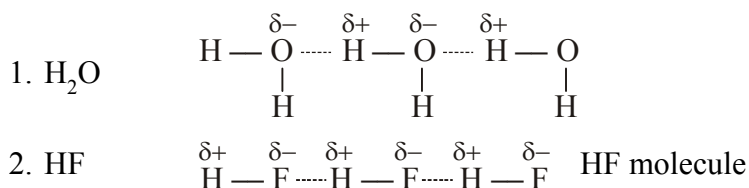

2. **Intramolecular Hydrogen bond:** It is formed when hydrogen atom is in between the two highly electronegative (F, O, N) atoms present within the same molecule.

Examples: O - nitrophenol the hydrogen is in between the two oxygen atoms.

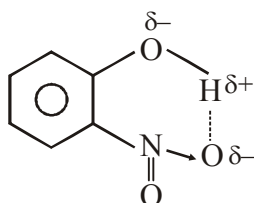

O - nitrophenol

Long Answer Type Questions (8 Marks)

1. Give an account of VSEPR Theory and its applications?

Ans. **VSEPR Theory:** In order to predict the shapes of covalent molecules a simple theory based on the repulsive interactions of the electron pairs in the valence shell of the atoms was developed Nyholm and Gillespie.

- The shape of a molecule depends on the number of pairs in the valence shell around the central atom.
- Pairs of electrons in the valence shell repel one another since their electron clouds are negatively charged.
- These pairs of electrons occupy such positions in space that minimise repulsion and thus maximum separation between them.
- The order of the repulsions between the electron pair is

lone pair - lone pair > lone pair - bond pair > bond pair - bond pair

No. of electron pairs	No. of Bond pairs	No. of lone pairs	Shape of the	Examples
2	2	0	Linear	BeCl ₂
3	3	0	Trigonal planar	BCl ₃
4	4	0	Tetrahedral	CH ₄
	3	1	Pyramidal	NH ₃
	2	2	Angular	H ₂ O
	1	3	Linear	HOCl
5	5	0	Trigonal bipyramidal	PCl ₅
6	6	0	Octahedral	SF ₆

Eg: 1. NH_3 Molecule Shape

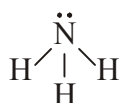

1. Total No. of electron pairs = 4
2. No. of Bond Pairs = 3
3. No. of Lone Pairs = 1
4. Shape - Pyramidal

2. H_2O Molecule Structure

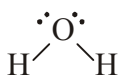

1. Total No. of electron pairs = 4
2. No. of Bond Pairs = 2
3. No. of Lone Pairs = 2
4. Shape - Angular

2. What do you understand by Hybridization? Explain different types of hybridization involving s and p orbitals?

Ans: **Hybridization:** Intermixing of atomic orbitals of almost equal energies of an atom and their redistribution into an equal number of identical orbitals is called Hybridization.

1. sp Hybridization: The phenomenon of intermixing of one 's' orbital and one 'p' orbital of an atom forming two 'sp' hybrid orbitals is called sp hybridization.

Each of the sp hybrid orbitals possesses $\frac{1}{2}$ s - character and $\frac{1}{2}$ p - character.

The bond angle in between two hybrid orbitals is 180° .

The shape of the molecule is linear.



Eg: Beryllium Chloride BeCl_2

1. In the formation of BeCl_2 molecule the central 'Be' atom undergoes sp hybridization.
2. Be - 4 - $1s^2 2s^2 2p^0$
 $1s^2 2s^2 2p^1$

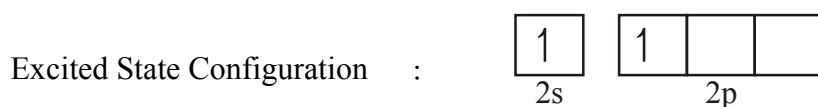
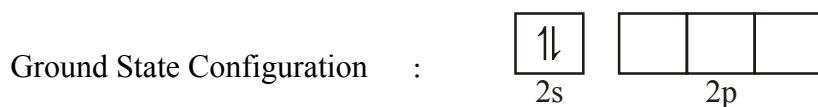

3. One s - orbital and one p - orbital of Be undergoes sp hybridization and forms two sp hybrid orbitals.
4. The two sp hybrid orbitals overlap with the 3p- orbital of chlorine axially and form two Be - Cl sigma bonds.
5. The shape of the molecule is linear and the bond angle is 180° .

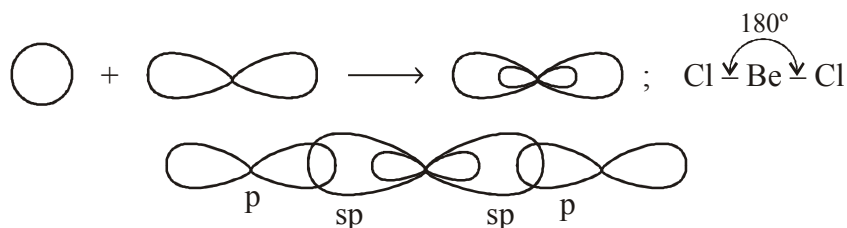

Linear Shape bond angle 180°

- 2) **sp^2 Hybridization:** The phenomenon of intermixing of one 's'orbital and two 'p'orbitals forming three ' sp^2 ' hybrid orbitals is called sp^2 hybridization. Each of the sp^2 hybrid orbitals possess $\frac{1}{3}$ s - character and $\frac{2}{3}$ p - character.

The bond angle is between any two sp^2 hybrid orbitals is 120° .

The shape of the molecule is planar triangular.

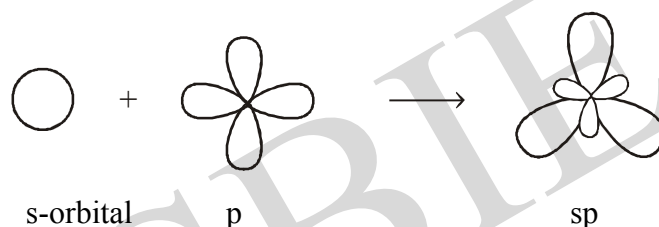

Example: Formation of Boron trichloride (BCl_3) molecule

- In the formation of BCl_3 molecule the central atom 'B' undergoes sp^2 hybridization.
- B - 5

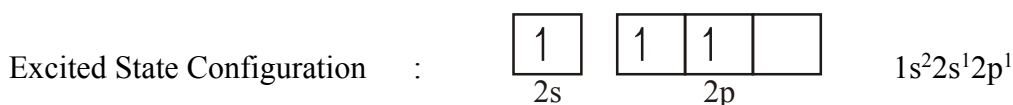
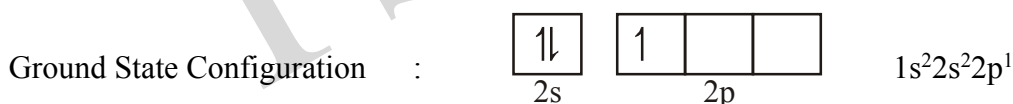

- One s- orbital and two p - orbitals of 'B' undergoes sp^2 hybridization and forms three sp^2 hybrid orbitals.
- The three sp^2 hybrid orbitals of 'B' overlap with singly occupied 3p orbitals of three chlorine atoms forms three B - Cl sigma bonds.
- The shape of the molecule is plane triangular with the bond angle 120° .

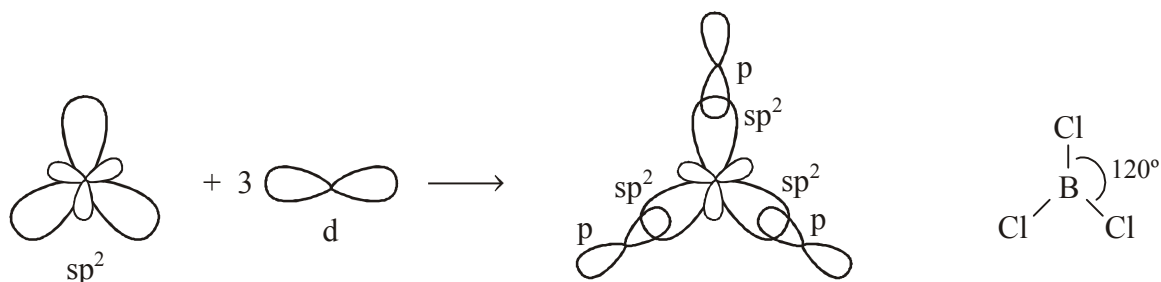
(b) Plane - triangular shape (b) Bond angle 120° **3) sp^3 hybridization:**

The phenomenon of intermixing of one 's' orbitals and three 'p' orbitals forming four sp^3 hybrid orbitals is called sp^3 hybridization.

Each of the sp^3 hybrid orbitals possess of $\frac{1}{4}$ s - character and of $\frac{3}{4}$ p - character.

The bond angle between any two sp^3 hybrid orbitals is $109^\circ 28'$.

The shape of the molecule in which the central atom undergoes sp^3 hybridization is tetrahedral.

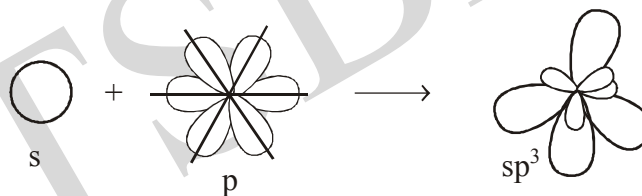
**Example: Formation of Methane (CH_4) Molecule:**

1. In the formation of CH_4 molecule the central atom 'c' undergoes sp^3 hybridization.

2. C - 6 $1s^2 2s^2 2p^2$

↑↓	1	1	
2s	2p		

 Ground State Configuration

$1s^2 2s^1 2p^3$

1	1	1	1
2s	2p		

 First Excited State Configuration

3. One s - orbital and 3 - p - orbitals of 'c' undergoes sp^3 hybridization and forms four sp^3 hybridization.

4. The sp^3 hybrid orbitals overlap with the s - orbital of three hydrogen atoms and form 4 C - H sigma bonds.

5. The shape of the molecule is tetrahedral and the bond angle is $109^\circ 28'$.

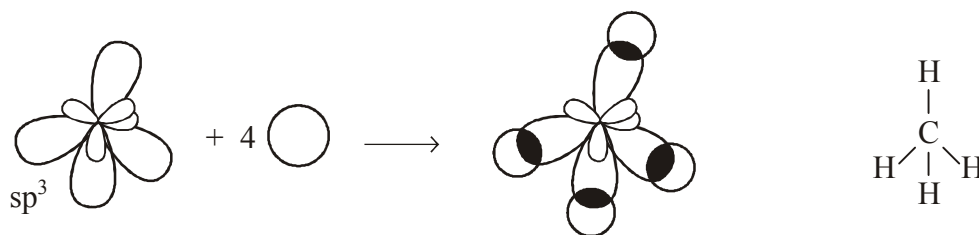

3. Give the Molecular Orbital Energy diagram of (a) N_2 and (b) O_2 . Calculate the respective bond order. Write the magnetic nature of N_2 and O_2 Molecule.

Ans. Molecular Orbital Energy diagram of N_2

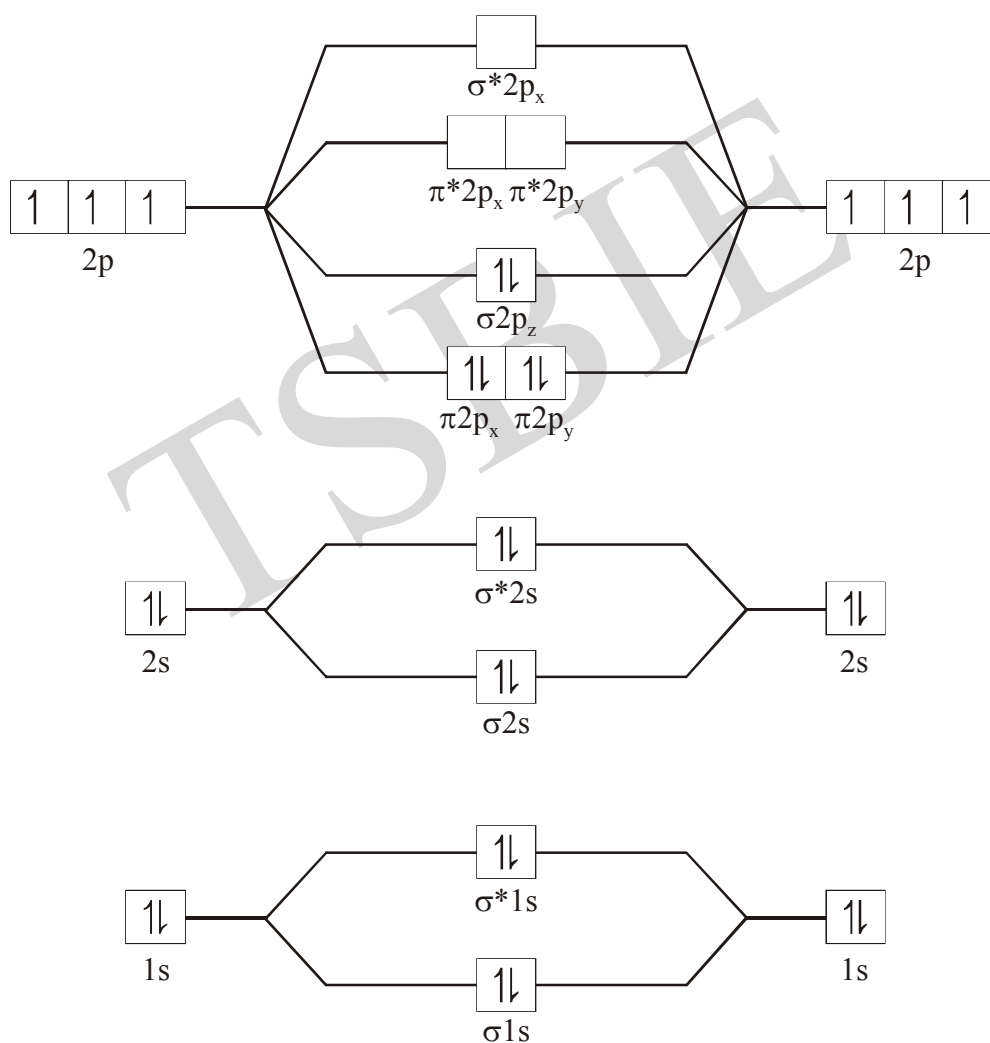

The electronic configuration of N_2 in terms of MO is given as

$$(\sigma_{1s})^2(\sigma^*_{1s})^2(\sigma_{2s})^2(\sigma^*_{2s})^2(\pi_{2p_x})^2(\pi_{2p_y})^2(\sigma_{2p_z})^2$$

$$\text{Bond Order} = \frac{\text{bonding electrons} - \text{antibonding electrons}}{2}$$

$$BO = \frac{1}{2}(N_b - N_a) = \frac{1}{2}(10 - 4) = 3 \quad (\because N \equiv N)$$

No unpaired electrons so it is diamagnetic in nature.

b) Molecular Orbital Energy diagram of O_2 :

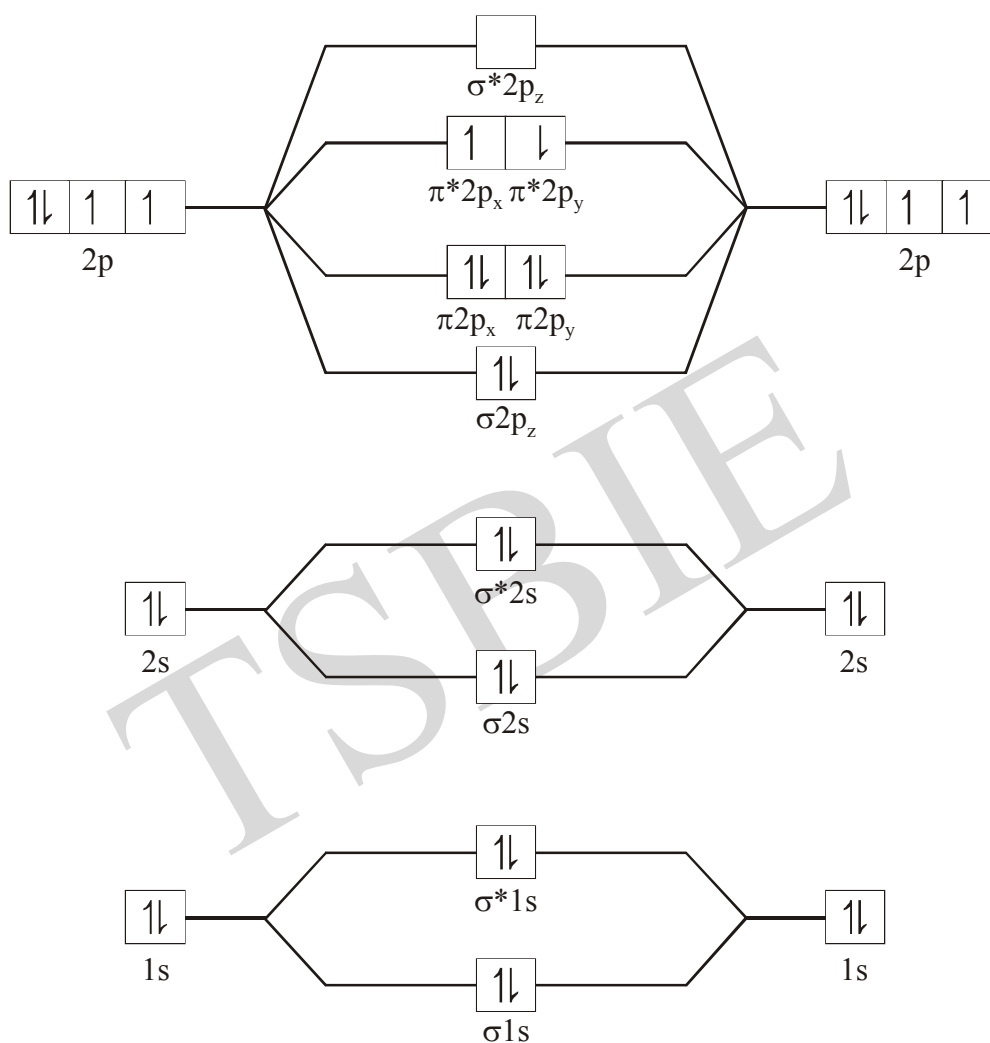

The electronic configuration of O_2 in terms of MO is given as

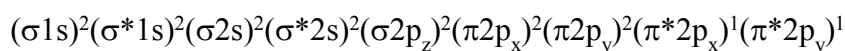

$$\text{Bond Order} = \frac{1}{2}(N_b - N_a)$$

$$= \frac{1}{2}(10 - 6) = 2 \quad (\because O = O)$$

Oxygen is having unpaired electrons so it shows paramagnetic nature.

States of Matter

Very Short Answer Type Questions (2 Marks)

1. State Boyle's Law. Give its mathematical expression.

Ans. At constant temperature, the pressure of a fixed amount of gas varies inversely with its volume. This is known as Boyle's Law.

Mathematically, it can be written as

$$V \propto \frac{1}{p} \text{ (at constant } T, n)$$

$$p = K_1 \times \frac{1}{V} \quad K_1 = \text{Proportionality constant}$$

2. State Charles's Law. Give its mathematical expression.

Ans. At constant pressure, the volume of a fixed mass of a gas is directly proportional to its absolute temperature.

$$V \propto T \text{ (at constant } P, n)$$

$$V = K_2 \times T \quad K_2 = \text{Proportionality constant}$$

3. State Avogadro's Law ?

Ans. It states that equal volume of all gases under the same conditions of temperature and pressure contain equal number of molecules.

$$V \propto n \text{ (Where } n \text{ is the number of moles of the gas)}$$

$$V = K_3 n \quad K_3 = \text{Proportionality constant}$$

4. State Graham's Law of diffusion?

Ans. The rate of diffusion of given mass of a gas is inversely proportional to the square root of its density.

It may be mathematically written as $r \propto \frac{1}{\sqrt{d}}$

$$\text{rate of diffusion of a gas } r = \frac{\text{Volume of the gas diffused (v)}}{\text{Time of diffusion (t)}}$$

r = rate of diffusion of the gas d = density of the gas.

5. State Dalton's Law of Partial Pressures?

Ans. It states that the total pressure exerted by the mixture of non-reactive gases is equal to the sum of the partial pressures of individual gases.

$$P_{\text{Total}} = P_1 + P_2 + P_3 + \dots \text{ (at constant T, V)}$$

6. What is Absolute Temperature?

Ans. The lowest hypothetical temperature of which gases are supposed to occupy zero volume is called Absolute Temperature which is -273.15°C or OK.

7. What is Gram Molar Volume?

Ans. One mole of any gas at STP conditions occupies 22.70198 litres. It is called Gram Molar Volume.

8. What is an Ideal gas?

Ans. The gas which obeys all gas laws at all temperature and pressures is called an Ideal gas.

9. Which of the gases diffuses faster among N_2 , O_2 and CH_4 ? Why?

Ans. CH_4 gas diffuses faster among N_2 , O_2 and CH_4 .

Reason: CH_4 (16) has lower molecular weight than N_2 (28) and O_2 (32).

10. How many times methane diffuses faster than Sulphur dioxide?

Ans. According to Graham's law of diffusion,

$$\frac{r_{\text{CH}_4}}{r_{\text{SO}_2}} = \sqrt{\frac{M_{\text{SO}_2}}{M_{\text{CH}_4}}} = \sqrt{\frac{64}{16}} = \sqrt{4} = 2$$

Hence Methane gas diffuses 2 times faster than SO_2 .

11. Give the relation between the partial pressure of a gas and its molefraction.

Ans. Partial Pressure of a gas = Molefraction \times total pressure.

$$P = x \times p_{\text{Total}}$$

12. Why Ideal gas equation is called Equation of State?

Ans. Ideal gas equation is a relation between four variables (P, V, n, T) and it describes the state of any gas. Hence it is called equation of state.

13. Give the Kinetic gas equation and write the terms in it.

Ans. Kinetic gas equation is $PV = \frac{1}{3} m n u_{\text{rms}}^2$

where

P = Pressure of the gas

V = Volume of the gas

m = mass of one molecule of the gas n = No. of molecules of the gas

u_{rms} = RMS speed of the gas molecules.

Short Answer Type Questions (4 Marks)

1. Derive Ideal gas equation.

Ans. By combining Boyle's Law, Charle's Law and Avogadro's Law we get an equation which relates to volume, pressure, absolute temperature and number of moles. This equation is known as Ideal gas equation.

At Constant T and n $V \propto \frac{1}{P}$ Boyle's Law

At Constant P and n $V \propto T$ Charle's Law

At Constant P and T $V \propto n$ Avogadro's Law

Thus, $V \propto \frac{1}{P} \times T \times n$

$$V = R \frac{nT}{P}$$

$\therefore PV = nRT$

V = Volume of the gas

P = Pressure of the gas

n = Number of Moles of Gas

T = Absolute temperature

R = Universal gas constant

2. Deduce (a) Boyle's Law and (b) Charle's Law from Kinetic gas equation.

Ans. (a) **Boyle's Law:** According to Kinetic gas equation

$$PV = \frac{1}{3} mnu_{rms}^2$$

$$PV = \frac{2}{3} \times \frac{1}{2} mnu_{rms}^2$$

The Kinetic energy of 'n' molecules in the gas is $KE = \frac{1}{2} mnu_{rms}^2$

According to the Kinetic molecular theory. Kinetic energy is directly proportional to the temperature on Kelvin Scale.

$$\frac{1}{2} mnu_{rms}^2 \propto T$$

or

$\frac{1}{2}mnu_{rms}^2 = K \times T$ where $K = \text{Constant}$ by substituting this in Kinetic gas equation we get

$$PV = \frac{2}{3}K \times T$$

$PV = \text{Constant}$

At Constant temperature $PV = \text{Constant}$. This is Boyle's Law.

b) Charle's Law

According to Kinetic gas equation

$$PV = \frac{1}{3}mnu_{rms}^2$$

$$PV = \frac{2}{3} \times \frac{1}{2}mnu_{rms}^2$$

The Kinetic energy of 'n' molecule in the gas is $K.E. = \frac{1}{2}mnu_{rms}^2$

According to Kinetic molecular theory, Kinetic energy is directly proportional to the temperature on Kelvin Scale.

$$\frac{1}{2}mnu_{rms}^2 \propto T$$

$$\text{or } \frac{1}{2}mnu_{rms}^2 = K \times T \quad \text{where } K = \text{constant}$$

by substituting this in Kinetic gas equation, we get

$$PV = \frac{2}{3}K \times T$$

$$\text{or } V = \frac{2}{3} \left[\frac{KT}{P} \right]$$

At Constant Pressure (P)

$V = \text{Constant} \times T$

or $V \propto T$ (P, n are Constant)

This is Charle's Law

3. Deduce (a) Graham's Law (b) Dalton's Law from Kinetic Gas Equation.

Ans. **(a) Graham's Law of Diffusion:**

According to Kinetic Gas Equation,

$$PV = \frac{1}{3}mnu_{rms}^2$$

'mn' represents mass of the gas.

If the gas contains Avogadro's number of molecules, then 'mn' becomes equal to gram molecular mass 'M' of the gas.

$$\therefore PV = \frac{1}{3} M u_{rms}^2 \text{ or}$$

$$\therefore u_{rms}^2 = \frac{3PV}{M} \Rightarrow u_{rms} = \sqrt{\frac{3PV}{M}}$$

Since, $\frac{V}{M} = \frac{\text{Gram under Volume}}{\text{Molar Mass}} = d(\text{density})$

$$\therefore u_{rms} = \sqrt{\frac{3P}{d}}$$

At Constant Pressure $u_{rms} = \frac{\text{Constant}}{\sqrt{d}}$

$$\therefore u_{rms} \propto \frac{1}{\sqrt{d}}$$

Rate of diffusion, $r \propto \frac{1}{\sqrt{d}}$ ($\because r \propto u_{rms}$)

This shows that the RMS speed or the rate of diffusion of gas is inversely proportional to the square root of its density.

This is Graham's Law of diffusion.

4. Write the postulates of Kinetic Molecular Theory of gases?

Ans. **Kinetic Molecular Theory of gases postulates:**

1. Gases contain large number of tiny particles called molecules. The molecules of gas are identical and moves with different velocities in random directions.
2. As the gas molecules are separated from each other by large distances, the volume of the molecules is negligible when compared to the volume of the gas.
3. There are no attractive or repulsive forces between the gas molecules.
4. Molecules of a gas are always in a state of random motion in all directions and in straight lines collecting with each other and with the walls of container.
5. The pressure of the gas is due to collision of gas molecules on the walls of the container.
6. The molecular collisions are perfectly elastic in there is no loss of total kinetic energy as a result of such collisions. But there may be exchange of energy among collecting molecules.
7. There is no gravitational force of attraction on the motion of gas molecules.

8. The average kinetic energy of gas molecules is directly proportional to absolute temperature. $(E_k) \propto T$.

5. State and explain Graham's law of diffusion.

Ans. At constant temperature and pressure, the rate of diffusion of a gas is inversely proportional to the square root of its density or molecular weight or vapour density

$$r \propto \frac{1}{\sqrt{d}}; r \propto \frac{1}{\sqrt{M}}; r \propto \frac{1}{\sqrt{D}}$$

If the times of diffusion are equal i.e. $t_1 = t_2$ then we can write

$$\frac{r_1}{r_2} = \frac{V_1}{V_2} = \sqrt{\frac{d_2}{d_1}} = \sqrt{\frac{VD_2}{VD_1}} = \sqrt{\frac{M_2}{M_1}}$$

If the volumes of the two gases are same is $V_1 = V_2$ then

$$\frac{r_1}{r_2} = \frac{t_1}{t_2} = \sqrt{\frac{d_2}{d_1}} = \sqrt{\frac{VD_2}{VD_1}} = \sqrt{\frac{M_2}{M_1}}$$

r_1 & r_2 are the rates of diffusion of two gases.

d_1 & d_2 are the densities of two gases.

VD_1 , VD_2 are the vapour densities of two gases.

M_1 & M_2 are the Molecular weights of two gases.

V_1 & V_2 are the Volumes of two gases.

t_1 & t_2 are the times of two gases.

Stoichiometry

Very Short Answer Type Questions (2 Marks)

1. How many number of moles of glucose are present in 540 gms of Glucose?

Ans. Weight of glucose = 540 g.

Molecular Weight of Glucose = $(C_6H_{12}O_6) = 180$.

$$\text{Number of Moles} = \frac{\text{Weight of the Substance}}{\text{G.W.M of the Substance}} = \frac{540}{180} = 3$$

2. Calculate the weight of 0.1 Mole of Sodium Carbonate?

Ans. Number of Moles of (Na_2CO_3) (n) = 0.1

G.M.W. of $Na_2CO_3 = 106$

Weight 'W' = $n \times \text{GMW} = 0.1 \times 106 = 10.6 \text{ g.}$

3. The empirical formula of a compound is CH_2O . Its Molecular Weight is 90. Calculate the Molecular formula of the compound?

Ans. Empirical formula (CH_2O) Weight = $12 + 2 + 16 = 30$

Molecular Weight = 90

$$n = \frac{\text{Molecular Weight}}{\text{Empirical Formula Weight}} = \frac{90}{30} = 3$$

Molecular Formula = $[\text{Empirical Formula}]_n = [CH_2O]_n$

$= (CH_2O)_3 = C_3H_6O_3$

\therefore Molecular Formula = $[C_3H_6O_3]$

Short Answer Type Questions (4 Marks)

4. Chemical analysis of a Carbon Compound gave the following percentage composition by weight of the elements present, Carbon = 10.06%, hydrogen = 0.84%, Chlorine = 89.10%. Calculate the Empirical Formula of the Compound?

Ans.

Element	Percentage	Atomic Weight	Atomic Ratio	Simple Ratio
C	10.06	12	$\frac{10.06}{12} = 0.84$	$\frac{0.84}{0.84} = 1$
H	0.84	01	$\frac{0.84}{1} = 0.84$	$\frac{0.84}{0.84} = 1$
Cl	89.10	35.5	$\frac{89.10}{35.5} = 2.51$	$\frac{2.51}{0.84} = 3$

$$\therefore \text{C} : \text{H} : \text{Cl} = 1 : 1 : 3$$

\therefore Hence, Empirical Formula of the Compound is CHCl_3 .

5. A Carbon Compound on analysis gave the following percentage composition, Carbon 14.5%, Hydrogen 1.8%, Chlorine 64.46%, Oxygen 19.24%. Calculate the Empirical Formula of the Compound?

Ans.

Element	Percentage	Atomic Weight	Atomic Ratio	Simple Ratio
C	14.5	12	$\frac{14.5}{12} = 1.21$	$\frac{1.21}{1.2} = 1 \times 2 = 2$
H	1.8	1	$\frac{1.8}{1} = 1.8$	$\frac{1.8}{1.2} = 1.5 \times 2 = 3$
Cl	64.46	35.5	$\frac{64.46}{35.5} = 1.81$	$\frac{1.81}{1.2} = 1.5 \times 2 = 3$
O	19.24	16	$\frac{19.24}{16} = 1.2$	$\frac{1.2}{1.2} = 1 \times 2 = 2$

$$\therefore \text{C} : \text{H} : \text{Cl} : \text{O} = 2 : 3 : 3 : 2$$

\therefore Hence, Empirical Formula of the Compound is $\text{C}_2\text{H}_3\text{Cl}_3\text{O}_2$.

6. A Carbon Compound contains 12.8% Carbon, 2.1% Hydrogen, 85.1% Bromine. The Molecular Weight of the Compound is 187.9. Calculate the Molecular Formula.

Ans.

Element	Percentage	Atomic Weight	Atomic Ratio	Simple Ratio
C	12.8	12	$\frac{12.8}{12} = 1.067$	$\frac{1.067}{1.067} = 1$

H	2.1	1	$\frac{2.1}{1} = 2.1$	$\frac{2.1}{1.067} = 2$
Br	85.1	80	$\frac{85.1}{80} = 1.067$	$\frac{1.067}{1.067} = 1$

$\therefore C : H : Br = 1 : 2 : 1$

\therefore Hence, Empirical Formula of the Compound is CH_2Br .

Empirical Formula Weight = $12 + 2 + 80 = 94$

But given Molecular Weight = 187.9 (or) 188.

$$\text{But, } n = \frac{\text{Molecular Weight}}{\text{Empirical Formula Weight}} = \frac{188}{94} = 2$$

Molecular formula = Empirical Formula $\times n$

$$= (CH_2Br) \times 2 = C_2H_4Br_2.$$

\therefore Molecular formula of Compound = $C_2H_4Br_2$.

7. What Volume of CO_2 is obtained at STP by heating 4g. of $CaCO_3$?

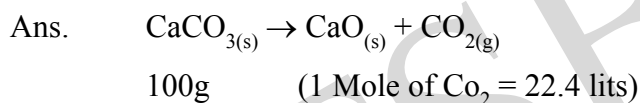

100g of $CaCO_3$ on heating gives 22.4 litres of CO_2 .

4g of $CaCO_3$ on heating gives

$$\Rightarrow \frac{4}{100} \times 22.4 = 0.896 \text{ Litres}$$

8. What are disproportionation reactions? Give Example?

Ans. The redox reaction, in which an element undergoes both Oxidation and reduction simultaneously is known as disproportionation reaction.

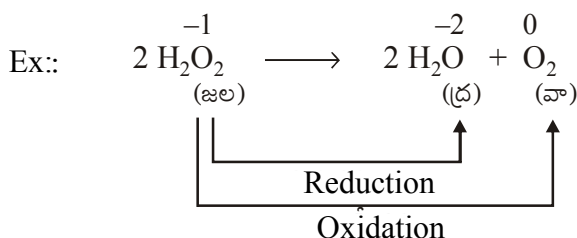

9. Assign Oxidation number to the underlines elements in each of the following species?

(a) $NaH_2\underline{P}O_4$ (b) $NaH\underline{S}O_4$ (c) $H_4\underline{P}_2O_7$ (d) $K_2\underline{Mn}O_4$ (e) $Ca\underline{O}_2$

(f) $Na\underline{B}H_4$ (g) $H_2\underline{S}_2O_7$

88. (a) NaH_2PO_4

$$1(+1) + 2(+1) + x + 4(-2) = 0$$

$$1 + 2 + x - 8 = 0$$

$$x - 5 = 0$$

$$\Rightarrow x = +5.$$

(b) NaHSO_4

$$1(+1) + 1(+1) + x + 4(-2) = 0$$

$$1 + 1 + x - 8 = 0$$

$$2 + x - 8 = 0 \Rightarrow x - 6 = 0$$

$$\Rightarrow x = +6.$$

(c) $\text{H}_4\text{P}_2\text{O}_7$

$$4(+1) + 2x + 7(-2) = 0$$

$$4 + 2x - 14 = 0$$

$$2x - 10 = 0$$

$$\Rightarrow x = +10/2.$$

$$\Rightarrow x = +5.$$

(d) K_2MnO_4

$$2(+1) + x + 4(-2) = 0$$

$$2 + x - 8 = 0$$

$$x - 6 = 0$$

$$\Rightarrow x = +6.$$

(e) CaO_2

$$1(+2) + 2(x) = 0 \Rightarrow 2x = -2$$

$$\Rightarrow x = -2/2.$$

$$\Rightarrow x = -1.$$

(f) NaBH_4

$$1(+1) + x + 4(-1) = 0$$

$$1 + x - 4 = 0 \Rightarrow x - 3 = 0$$

$$\Rightarrow x = +3.$$

(g) $\text{H}_2\text{S}_2\text{O}_7$

$$2(+1) + 2(x) + 7(-2) = 0$$

$$2 + 2x - 14 = 0 \Rightarrow 2x - 12 = 0$$

$$\Rightarrow x = 12/2.$$

$$\Rightarrow x = +6.$$

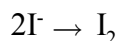
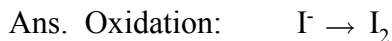
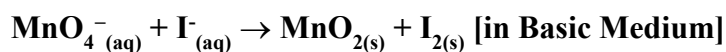
10. Balance the following redox reaction by ion- electron method?

Balance electrically

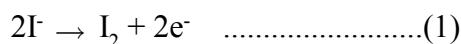

Balance 'O' by adding H_2O



Balance 'H' by adding H_2O on the side deficient in H and in adding same number of OH^- on the opposite side.



Balance electrically by adding electrons

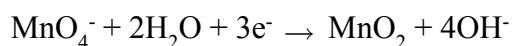

Multiply eqn. (1) by 3 & eqn. (2) by (2) to equalise electrons and add

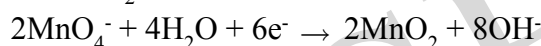
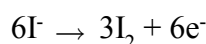
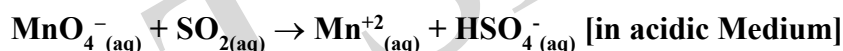
**11. Balance the following redox reaction by ion electron method:**

Ans. **Oxidation Half Reaction**

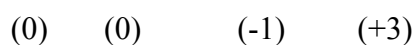
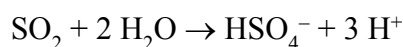
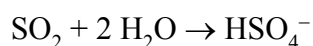
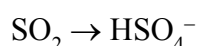
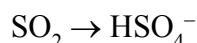

\therefore 2 Electrons are to be subtracted

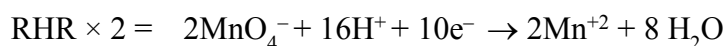
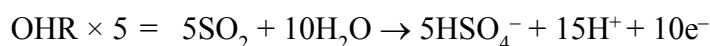

Reduction Half Reaction

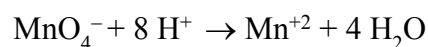
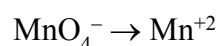
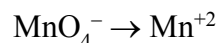

\therefore 5 electrons are to be added.

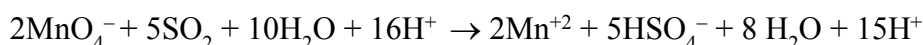
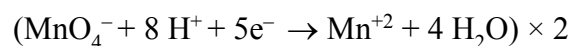

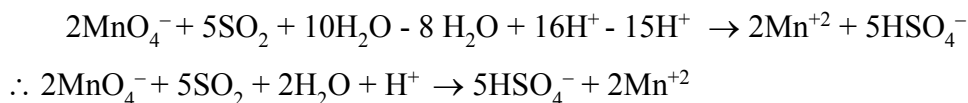

12. Balance the following redox reaction by Ion Electron Method":

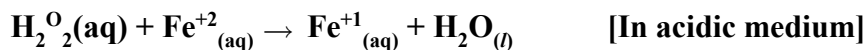

Ans. O.H.R

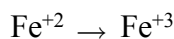

R.H.R

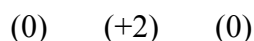
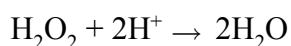
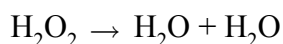
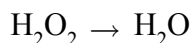

$$+ 2 + x = 0$$

$$x = -2$$

Hence, two electrons are to be added.

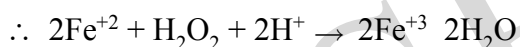
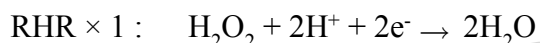
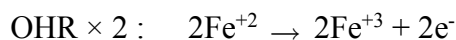

13. Balance the following redox reaction by Ion electron Method:



Ans. OHR

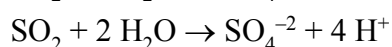
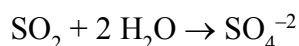
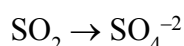
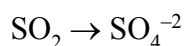

RHR

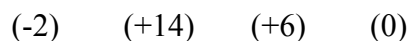
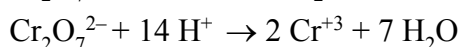
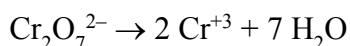
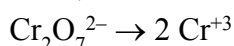
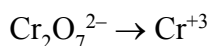

Hence, 2 electrons are to be subtracted $12 + x = +6$



Hence, six electrons are to be added

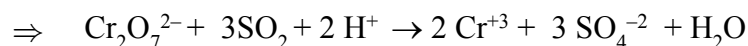
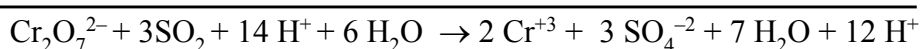
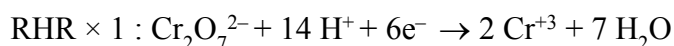
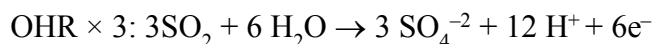
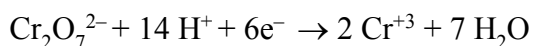

Thermo Dynamics

Very Short Answer Type Questions (2 Marks)

1. Define a System. Give an example?

Ans. A small part of Universe that is chosen for thermodynamics study is called System.

Eg: Water in beaker.

2. State the 1st Law of Thermodynamics?

Ans. Energy can neither be created nor be destroyed.

3. What are the ' ΔH ' sign convention for Exothermic and Endothermic Reactions?

Ans. For Exothermic Reaction, $\Delta H = -ve$

For Endothermic Reaction, $\Delta H = +ve$

4. What are the Extensive and Intensive Properties?

Ans. Measurable properties of a system may be classified into two types (i) Extensive (ii) Intensive Properties.

(i) Extensive Properties: The properties of a system which depend on the total amount of the material present the system are called Extensive Properties.

Ex: Mass (m), Volume (v), Internal Energy (E), Heat Energy (or) Heat Content (H) etc.

(ii) Intensive Properties: The properties of a system which are independent of amount of material in the system are called Intensive Properties.

Ex: Density, Surface tension (s), Specific Heat, Pressure etc.

5. Give the equation that gives the relationship between ΔU and ΔH .

Ans. $\Delta H = \Delta U + \Delta nRT$

ΔH = Enthalpy change,

Δn = Change in No. of Moles

ΔU = Change in Internal Energy

R = Universal gas Constant

T = Temperature

6. State the 3rd Law of Thermodynamics?

Ans. At absolute zero the entropy of any pure crystalline substance approached zero.

Short Answer Type Questions (4 Marks)**7. Explain the state function 'Enthalpy', 'H'. What is the relationship between ΔU and ΔH ?**

Ans. The heat absorbed at a constant volume is equal to change in the internal energy $\Delta U = q_v$. But in the heat absorbed at constant pressure, apart of it increases the internal energy ΔU and the remaining part is used in the expansion work done by the system. If the initial state is represented with a subscript 1 and the final state with a subscript 2. The the above equation written as

$$U_2 - U_1 = q_p - P(V_2 - V_1)$$

(or)

$$q_p = (U_2 + PV_2) - (U_1 + PV_1)$$

The value of $U + PV$ is called Enthalpy and represented by H .

So, Enthalpy.

$$H = U + PV$$

$$q_p = H_2 - H_1 = \Delta H$$

Though 'q' is path function, H is a state function because it depends on U , P and V , all of which are state functions.

Therefore, ΔH is dependent of path.

The relation between ΔU and ΔH is

$$\Delta H = \Delta U + P\Delta V \quad (\because P\Delta U = W)$$

8. Show that $\Delta H = \Delta U + \Delta n_{(g)}RT$?

Ans. In the reaction involving gaseous substances there is significant different in ΔH and ΔU .

If V_A is the total volume of the gaseous reactions V_B is the total volume of the gaseous products, n_A is the number of moles of gaseous reactions and n_B is the number of moles of gaseous products, all at constant pressure and temperature, then using ideal gaseous.

$$PV_A = n_A RT$$

$$PV_B = n_B RT$$

$$\text{Thus, } PV_B - PV_A = n_B RT - n_A RT$$

(or)

$$\Rightarrow P(V_B - V_A) = (n_B - n_A)RT$$

(or)

$$\therefore P\Delta V = \Delta n_{(g)}RT.$$

Here, $\Delta n_{(g)}$ is number of moles of gaseous products - number of moles of gaseous reactants.

Substituting the value of $P\Delta V$ in

$$\Delta H = \Delta U + P\Delta V$$

$$\text{We get, } \Delta H = \Delta U + \Delta n_{(g)}RT$$

9. Define and explain the standard enthalpy of formation ($\Delta_f H^\ominus$).

Ans. The Enthalpy of formation is the heat change accompanying the formation of one mole of a compound from its constituent elements. It is generally denoted by $\Delta_f H^\ominus$. For example the Enthalpy of formation of Carbondioxide can be represented as



When all the species of chemical reactions are in their standard states, the Enthalpy of formation is called Standard heat of formation. It is denoted by ΔH^\ominus .

10. State and Explain Hess's Law of Constant heat summation?

Ans. **Hess's Law:** Energy changes remains constant whether the reactions takes place in single step or in several steps.

Formation of CO_2 : CO_2 can be formed either in one step or in two steps.

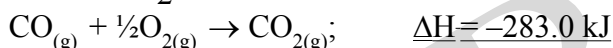
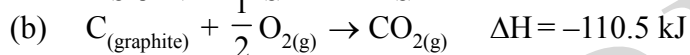
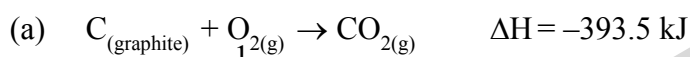

Reaction 'a' is completed in single step and reaction 'b' is completed in two steps. But in both the cases energy changes remain constant, which proves Hess's Law.

11. Define and explain the Enthalpy of combustion ($\Delta_c H^\ominus$).

Ans. It is the enthalpy change accompanying the complete combustion of one mole of a substance in excess of oxygen or air.

For example, the enthalpy of combustion of carbon is represented as

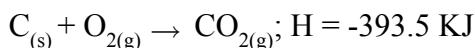

Combustion reactions are always accompanied by the evolution of heat, therefore the value of $\Delta_c H$ is always negative.

12. Calculate $\Delta_n G^\ominus$ for conversion of Oxygen to Ozone $\frac{3}{2}O_{2(g)} \rightarrow O_{3(g)}$ at 298k. k_p the reaction is 2.43×10^{-29} .

$$\text{Ans. } \Delta_n G^\ominus = 2.30RT \text{ Log } k_p$$

$$k_p = 2.43 \times 10^{-29}$$

$$\Delta_n G^\ominus = -2.303 \times 8.314 \times 298 (\log 2.43 \times 10^{-29})$$

$$\Delta_n G^\ominus = 163 \text{ kJ.}$$

13. State the second law of thermodynamics and explain it?

Ans. Second law of thermodynamics may be stated as Heat can't flow from a colder body to a hotter body on its own.

(or)

Heat cannot be converted into work completely without causing some permanent changes in the system involved or in the surroundings.

Second Law of thermodynamics is useful in predicting

- (1) Whether a process occurs in a specified direction or not on its own without the intervention of any external agency i.e., whether a process is spontaneous or not in specified direction.
- (2) The transformation or a process occurs what fraction of one form of energy is converted into another form of energy in this transformation or process.
- (3) A machine which transfers heat from lower temperature to higher temperature on its own is called perpetual motion machine of second kind. Second law of thermodynamics predicts that perpetual motion machine is not possible.

14. What is Entropy? Explain with examples?

Ans. **Entropy:** Entropy means randomness. it is denoted by 's'. Entropy is a measure of disorder or randomness in a system. The greater the disorder in a system the higher is the Entropy. Entropy is a state function. Entropy change (ΔS) between any two states is therefore given by the equation.

$$\Delta S = \frac{q_{rev}}{T}$$

q_{rev} is heat absorbed by the system isothermally and reversibly at 'T' during the state change. A substance in solid state have lowest entropy because the particles are orderly arranged. The gaseous state of the same substance have highest entropy because the particles are moving most disorderly. The liquid state of the same substance have entropy in between the value for solid and the gaseous state.

For a spontaneous process in an isolated system the change in entropy (ΔS) is positive.

15. State the first law of thermodynamics. Explain its mathematical notation.

Ans. Energy can neither be created nor be destroyed but energy in a process may be converted from one form to another form. First law of thermodynamics is also known as law of Conservation of energy.

Mathematically, first law of thermodynamics can be represented as

$$Q = \Delta E + W$$

Where, Q = Amount of heat absorbed by the system

ΔE = Increase in internal energy of the system

W = Work done on a system.

For infinitesimally small changes $q = dE + W$

According to first law of thermodynamics a part of amount of heat (Q) absorbed by the system is used for increasing the internal energy (ΔE) of the system and the remaining part is used for doing work (W).

Heat absorbed by the system is given + sign,

Heat given out by the system is given – sign.

Work done by a system is given – sign and work done on a system is given + sign.

Chemical Equilibrium and Acids - Bases

Very Short Answer Type Questions (2 Marks)

1. State law of Chemical Equilibrium.

Ans. At a given temperature, the product of concentration of the reaction product raised to the respective stoichiometric coefficients in the balanced chemical equation divided by the product of concentrations of the reactants raised to their individual stoichiometric coefficients has a constant value. This is known as the Equilibrium Law (or) Law of Chemical Equilibrium.

2. What is Homogenous Equilibrium? Write two Homogeneous reactions?

Ans. The Equilibrium in which all the substances are present in the same phase is known as Homogeneous Equilibrium.

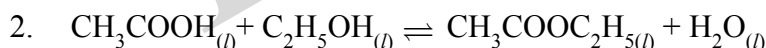
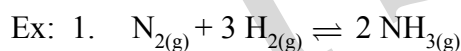

3. What is Heterogeneous Equilibrium? Write two Heterogeneous reactions?

Ans. The Equilibrium in which the substances involved are present in different phases is called Heterogeneous Equilibrium.

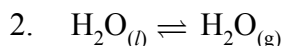
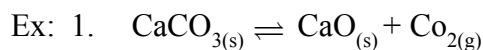

4. Define the Equilibrium Constant?

Ans. The ratio of product of molar concentration of products to product of molar concentration of reactants at a given temperature is called Equilibrium Constant.

5. Write the relation between K_p and K_c ?

Ans. $K_p = K_c(RT)^{\Delta n}$

$\Delta n = [\text{Number of moles of gaseous products} - \text{Number of moles of gaseous reactants}]$

6. Can Catalyst disturb the state of Equilibrium?

Ans. No, but equilibrium is attained quickly because the Catalyst increases both the rate of forward and backward reactions.

7. What is the effect of temperature on a system at Equilibrium?

Ans. Increase in temperature favours Endothermic Reactions,
Decrease in temperature favours Exothermic Reactions.

8. What is a Bronsted Base? Give One Example.

Ans. Proton acceptor is called "Bronsted Base".

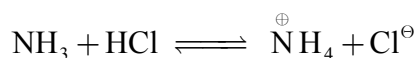

In the above reaction, NH_3 accepts a proton H^+ from HCl , so NH_3 is a Bronsted Base.

9. What is Lewis acid? Give an example.

Ans. Lewis acid is the substance which can accept a pair of electrons.

Ex: BF_3 .

10. All Bronsted bases are Lewis bases. Explain?

Ans. Bronsted base is a proton acceptor Lewis base is an electron pair donor. In order to accept a proton, bronsted base must donate an eletron pair.

Hence, All Bronsted bases are Lewis bases.

**11. All Lewis acids are not Bronsted acids. Why?**

Ans. Substances which accept electron pair are Lewis acids.

Ex: BF_3 can accept pair of electrons. Hence, it is an Lewis acid.

Substances which donate proton are Bronsted Base.

Ex: HCl .

Though BF_3 is an Lewis acid, it does not have a proton, so it is not a Bronsted Base. Hence, Lewis acids are not Bronsted acids.

12. Ice melts slowly at high attitudes. Explain why?

Ans. Ice has more volume than water. When pressure is increased Ice converts into water. When Pressure is decreased the above reaction occurs slowly. Since, at high attitudes pressure is low, Ice melts slowly.

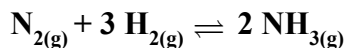
Short Answer Type Questions (4 Marks)**1. Derive the relation between K_p and K_c for the equilibrium reaction.**

Ans. $\text{N}_{2(g)} + 3 \text{H}_{2(g)} \rightleftharpoons 2 \text{NH}_{3(g)}$

$$K_C = \frac{[\text{NH}_3]^2}{[\text{N}_2][\text{H}_2]^3}, \quad K_P = \frac{P_{\text{NH}_3}^2}{P_{\text{N}_2} \times P_{\text{H}_2}^3}$$

$$PV = nRT \Rightarrow P = \frac{n}{V}RT$$

$$\Rightarrow P = cRT \quad (\because n/V = \text{con} = C)$$

$$\therefore P_{\text{NH}_3} = [\text{NH}_3]RT$$

$$P_{\text{N}_2} = [\text{N}_2]RT$$

$$P_{\text{H}_2} = [\text{H}_2]RT$$

$$K_P = \frac{\{[\text{NH}_3]RT\}^2}{\{[\text{N}_2]RT\}\{[\text{H}_2]RT\}^3}$$

$$K_P = \frac{[\text{NH}_3]^2}{[\text{N}_2][\text{H}_2]^3} (RT)^{2-4} = K_C (RT)^{-2}$$

$$K_P = K_C (RT)^{-2}$$

$$K_P = \frac{K_C}{(RT)^2}$$

$$K_P (RT)^2 = K_C \therefore K_C > K_P \text{ (or) } K_P < K_C$$

2. Explain the Arrhenius concept of acids and bases.

Ans. 1. Acids are substances that dissociate into water to give hydrogen ions $\text{H}^+_{(\text{aq})}$ and bases are substances that produce hydroxyl ions $\text{OH}^-_{(\text{aq})}$

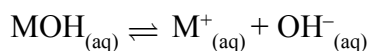
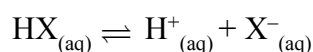

2. Acids such as HCl, HNO_3 undergo almost complete ionization. These are strong acids. Acids such as acetic acid (CH_3COOH) undergoes partial ionization. Hence it is a weak acid. In the same manner bases which undergo complete ionization are strong bases the ones which undergo partial ionization are weak bases.

3. According to this theory neutralization reaction is formation of water by the combination of H^+ , OH^- ions.

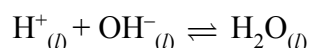

3. What is the conjugate acid base pair? Illustrate with an examples.

Ans. A pair of acid and base that differ by 'One Proton' is called as Conjugate acid base pair.

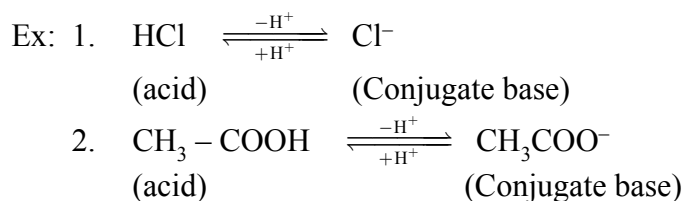

4. The Species H_2O , HCO_3^- , HSO_4^- and NH_3 can act both as Bronsted acids and bases. Give the corresponding conjugate acid and base for each of them.

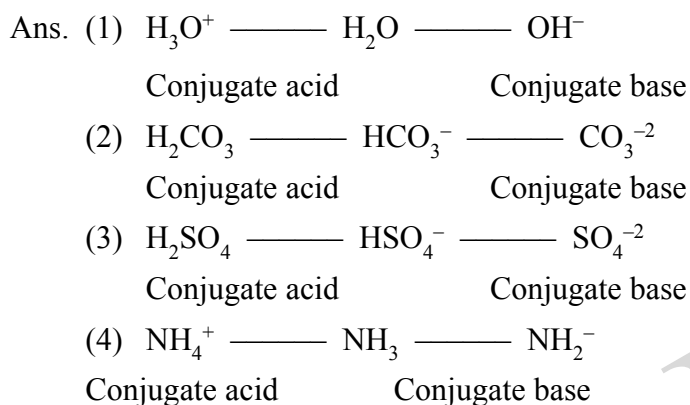

5. Write the Conjugate acid and Conjugate base of each of following:

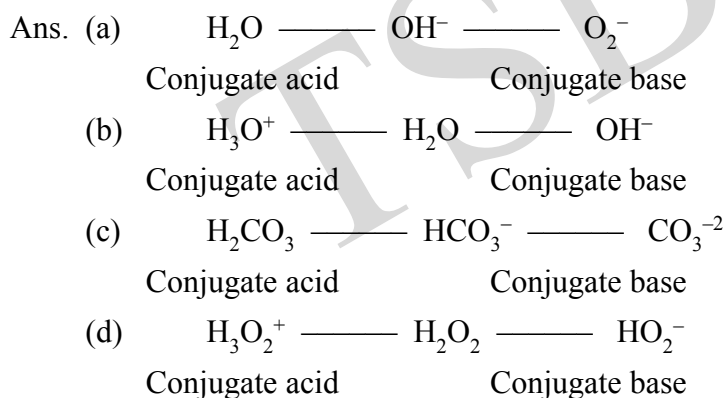

6. Discuss the Application of Lechatlier's Principle for the Industrial Synthesis of Ammonia.

Ans. **Lechatlien's Principle:** When a system at Equilibrium is subjected to stress (like change in pressure, temperature and concentration) the equilibrium position shifts in the directions where the stress is reduced (or) nullified.

Applying Lechatlien's principle to synthesis of NH_3 by Haber's Process:



Effect of Concentration: According to Lechatlier's Principle increase in the concentration of N_2 and H_2 favours the forward reaction there by increases the formation of NH_3 .

Effect of Temperature: Formation of NH_3 is a Exothermic Reaction. According to Lechatlier's principle low temperature favours the forward reaction. But at low temperature reaction is very slow. Hence optimum temperature (725k - 775k) is used in Haber's Process.

Effect of Pressure: The formation of ammonia is accompanied with decrease in number of moles ($4 \rightarrow 2$). So, high pressure is required for the better yield of ammonia. Hence 200 at m pressure is used in Haber's Process.

Optimum Condition:

Pressure : 200 at m

Temperature : 725 - 775k

Catalyst : Iron (Fe)

7. Discuss the application of Lechatlier's principle for the industrial synthesis of sulphur trioxide.

Ans: **Lechatlien's Principle:** When a system at equilibrium is subjected to stress (like change of pressure, temperature and concentration) the equilibrium position shifts in the direction where the stress is reduced (or) nullified.

Properties of SO_3



Effect of Concentration: According to Lechatlien's Principle increase in the concentration of reactants favours the forward reaction. Hence high concentration of SO_2 and O_2 are required for better yield of SO_3 .

Effect of Temperature: Formation of SO_3 is a Exothermic Reaction. According to Lechatlien's Principle low temperature favours the forward reaction. Hence, Temperature 673k is used.

Effect of Pressure: The formation of SO_3 is accompanied with decrease in number of moles ($3 \rightarrow 2$). So, high pressure is required for the better yield of SO_3 . Hence, to get better yield of SO_3 2 atm pressure is used.

Optimum Condition:

Temperature : 675k

Pressure : 2 atm

Catalyst : V_2O_5

* **** *

Hydrogen and its Compounds

Very Short Answer Type Questions (2 Marks)

1. Define the term Hydride. How many categories of hydrides are known? Name them.

Ans. Dihydrogen, under certain reaction conditions, combines with almost all elements, except Noble gases, to form binary compounds called 'Hydrides'.

Hydrides are classified into three categories:

- (i) Ionic or Saline or Salt like hydrides.
- (ii) Covalent or molecular hydrides.
- (iii) Metallic or non-stoichiometric hydrides.

2. What do you mean by autoprotolysis? Give the equation to represent the autoprotolysis of water.

Ans. Water has the ability to behave as an acid as well as base. It behaves as an amphoteric substance. The self-ionising property of water is called autoprotolysis. The autoprotolysis of water is represented by equation

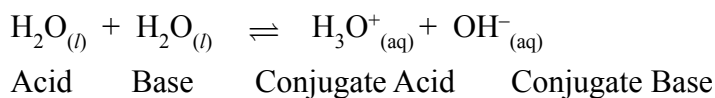

3. Water behaves as an amphoteric substance in the Bronsted sense. How do you explain?

Ans. Water has the ability to act as an acid as well as a basic i.e. It behaves as an amphoteric substance. In the Bronsted sense it acts as an acid with NH_3 and a base with H_2S .

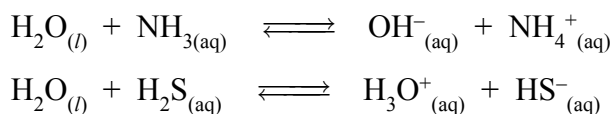

Short Answer Type Questions (4 Marks)

4. Discuss the position of Hydrogen in the periodic table on the basis of its electronic configuration.

Ans. Hydrogen is the first element of the Periodic Table with atomic number 1 and electronic configuration is $1s^1$. It acts as both Alkali metals (Group IA) and halogen (Group VIIA) and can be placed along with them.

Reasons for position of Hydrogen in Group IA:

- (i) The outer electronic configuration of 'H' and Group IA are same i.e., $1s^1$.
- (ii) Similar to Alkali metals, hydrogen also forms oxides, halides and sulphides.
Eg: NaCl, HCl; Na_2S , H_2S ; Na_2O , H_2O
- (iii) Like Alkali metals, hydrogen loose one electron to form unipositive ion.

Reasons for position of hydrogen in VIIA

- (i) Like halogens, hydrogen also requires one electron to achieve the Noble gas configuration ($1s^2 = \text{Helium}$).
- (ii) Similar to halogens, hydrogen also forms diatomic molecule.
- (iii) Like halogens, hydrogen gain one electron to form uninegative ion.

5. Write a note on Heavy Water.

Ans. (i) It can be prepared by exhaustive electrolysis of water or as a by product of some fertilizer industries.

(ii) It is used for the preportion of other deuterium compounds. For example:

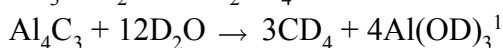
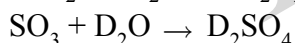
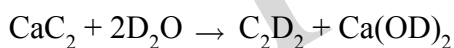

(iii) It is used as a moderate in nuclear reactors and in exchange reactions for the study of reaction mechanism.

6. Name the isolopes of hydrogen. What is the ratio of the masses of these isotopes?

Ans. Hydrogen has three isotopes namely Protium (${}_1^1H$), Deuterium (${}_1^2H$ or ${}_1^2D$) and Tritium (${}_1^3H$ or ${}_1^3H$). These isotopes differ from each other in the presence of Neutrons. Protium has no neutrons, Deuterium has one neutron and Tritium has two neutrons in their nuclear respectively.

Of these isotopes, only tritium is radio active and emits low energy β particles.

Relative ratio of the masses of isotopes are

Protium : Deuterium : Tritium = 1008 : 2014 : 3016

Protium : Deuterium : Tritium = 1 : 2 : 3

7. Discuss the principle and the method of softening of hard water by synthetic, ion - exchange resins.

Ans. **Principle:** In synthetic resins method, the cations and anions present in water are exchanged by H^+ , OH^- ions for removing permanent hardness of water.

Cation exchange Resins:

The REesins contain $-OH$, $-COOH$ (or) $-SO_3H$ group. When hard water is passed through these Resins, Na^+ , Ca^{2+} , Mg^{2+} and other cations present in water are exchanges to H^+ .

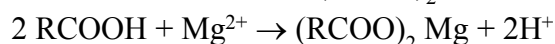
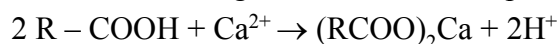

Anion Exchange Resin:

These Resins contain $R - NH_2$ groups. When hard water is passed through these Resins, Cl^- , HCO_3^- , SO_4^{2-} and other anions present in water are exchanged by OH^- .

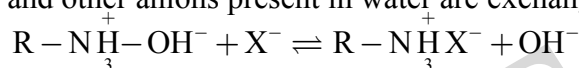

Where $X = Cl^-$, HCO_3^- , SO_4^{2-}



Thus ion exchange method removes dissolved salt from water and produces soft water.

8. Write a few lines on the utility of Hydrogen.

- Ans. 1. The combustion of hydrogen produces large amount of heat energy when compared with other fuels like Petrol, LPG etc.
2. Hydrogen fuel is used for generating electrical energy.
3. Hydrogen is used as Rocket fuel.
4. Atomic and Oxyhydrogen torches are used for welding and cutting of Metal.
5. The combustion of fuel will give less pollutants than in Petrol.

9. Explain with suitable examples, the following:

(i) Electron deficient (ii) Electron Precise (iii) Electron rich hydrides.

Ans. **(i) Electron deficient:** An electron deficient hydride, as the name suggests, has too few electrons for writing its conventional Lewis structure. Diborane (B_2H_6) is an example. Infact, all the elements of Group 13 will form electron deficient compounds and they act as Lewis Acids.

(ii) Electron Precise: These compounds have the required number of electrons to write their conventional lewis structures. All elements of Group 14 form such compound (Eg. CH_4) which are tetrahedral in geometry.

(iii) Electron - Rich hydrides: Electron rich hydrides have excess electrons which are present as lone pairs. Elements of group 15 - 17 form such compounds. (NH_3 - One lone pair) H_2O - 2 and HF - 3 lone pairs). They behave as lewis bases i.e. electron donors. The presence of lone pairs on highly electronegative atoms like N, O and 'F' in hydrides results in hydrogen bond formation between the molecules. This will lead to association of molecules.

s-Block Elements

Very Short Answer Type Questions (2 Marks)

1. Give reasons for the diagonal relationship observed in the Periodic Table.

Ans. The diagonal relationship is observed in the Periodic Table due to

- (i) Similar sizes of atoms or ions.
- (ii) Similar electronegativities of the respective elements.
- (iii) Diagonally similar elements possess same polarising power.

$$\text{Polarising Power} = \frac{\text{Ionic Charge}}{(\text{Ionic Radius})^2}$$

2. Write completely the electronic configuration of K and Rb.

Ans. Potassium (K) : $19 - 1s^2 2s^2 2p^6 3s^2 3p^6 4s^1$

Rubidium (Rb) : $37 - 1s^2 2s^2 2p^6 3s^2 3p^6 4s^2 3d^{10} 4p^6 5s^1$

3. Lithium Salts are mostly hydrated. Why?

Ans. Lithium salts are mostly hydrated due to

- (a) Smaller size (ii) High hydration energy

Eg: $\text{LiCl} \cdot 2\text{H}_2\text{O}$

4. Which of the alkali metals shows abnormal density? What is the order of the variation of density among the IA group elements?

Ans. K^+ (Potassium) shows abnormal density to release in atomic size and presents of vacant '3d' orbital. The order of variation of density is

$\text{Li} < \text{Na} > \text{K} < \text{Rb} < \text{Cs}$

5. Lithium reacts with water less vigorously than Sodium. Give your reasons.

Ans. Lithium reacts with water less vigorously than Na^7 (Sodium) as it has high small size and high hydration energy when compared to Sodium.

6. Write the complete electronic configuration of any two alkaline earth metals.

- Ans. Beryllium (Be = 4) - $1s^2 2s^2$
 Magnesium (Mg = 12) - $1s^2 2s^2 2p^6 3s^2$
 Calcium (Ca = 20) - $1s^2 2s^2 2p^6 3s^2 3p^6 4s^2$

7. What are the characteristic colours imparted by the IIA elements?

Ans. 'Be' and 'Mg' do not impart any colour because the electrons in 'Be' and 'Mg' are strongly bounded.

When exposed to Bunsen burner, other elements impart characteristic colour.

- Calcium (Ca) : Brick Red
 Strontium (Sr) : Crimson
 Barium (Ba) : Apple Green

8. What happens when Magnesium metal is burnt in air?

Ans. When Magnesium is burnt in air, it results in the formation of MgO and Mg_3N_2 and burns with dazzling brilliant white light in air.

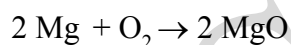
**9. Write a balanced equation for the formation of ammoniated IIA metal ions from the metals in liquid ammonia.**

Ans. The alkaline earth metal dissolves in liquid ammonia to form ammoniated ions giving a deep blue-black solution.

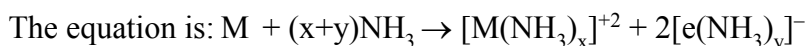
**10. Why are alkali metals not found in the free state in nature.**

Ans. The alkali metals are highly reactive due to their large size and low ionization enthalpy. Hence they do not occur in the free state.

11. Write the uses of 'Mg' metal.

- Ans. (i) Magnesium is used in the production of alloys in combination with Aluminium, Zinc, Magnesium and tin.
 (ii) It is used in the construction of aircrafts.
 (iii) Milk of magnesia (a suspension of $\text{Mg}(\text{OH})_2$ in H_2O) is medically liked as an antacid.

Short Answer Type Questions (4 Marks)**12. Write a note on the anomalous behaviour of Beryllium.**

Ans. The properties exhibited by the 'Be' are different from other elements due to its small atomic and ionic size and high Ionization enthalpy.

- (i) Beryllium compounds are largely covalent.
- (ii) It is amphoteric in nature.
- (iii) It does not respond to the flame test whereas remaining elements impart colour.
- (iv) It cannot decompose water at normal temperature.
- (v) It can form many complexes whereas other elements of the group cannot form complexes.

13. 'Be' shows diagonal relationship with 'Al'. Discuss.

Ans. 'Be' resembles 'Al' due to its similar charge to radius ratio.

The similar properties are:

- (i) Both have same electronegativity value (i.e. 1.50).
- (ii) Compounds of both 'Be' and 'Al' undergo hydrolysis.
- (iii) Both Be and Al are amphoteric in nature.
- (iv) Both Be and Al are not attacked by acids due to the presence of oxide film on the surface of these metals.
- (v) Salts of both Be and Al are extensively hydrolysed.

p-Block Elements - Group 13**Very Short Answer Type Questions (2 Marks)**

1. How do you explain higher stability of TlCl?

Ans. TlCl exhibits +1 and +3 oxidation states. But the +1 oxidation state of Thallium is most important than +3 due to inert pair effect.

2. Why does BF_3 behave as a Lewis Acid.

Ans. BF_3 is an electron deficient compound. There are only 6 electrons around Boron in BF_3 . So, it has a tendency to accept 2 electrons to complete its octet configuration. According to Lewis Theory, an electron pair acceptor is an acid. Hence, BF_3 is a Lewis Acid.

3. Describe the shapes of BF_3 and BH_4^- . Assign the hybridization of Boron in these species.

Ans. The Hybridization of B in BF_3 is sp^2 . Hence the geometry of BF_3 molecule is triangular planar.

This shape is obtained by the overlap of these sp^2 hybridised orbitals of Boron with the 'p' orbitals of fluorine atoms.

BH_4^- : In BH_4^- the hybridisation of Boron is sp^3 . Hence the shape of Tetrahedral.

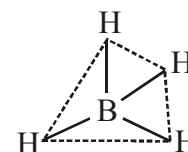
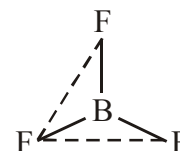

4. Explain inert pair effect.

Ans. The reluctance of 'ns' electrons to participate in the bond formation is known as Inert Pair effect.

Eg: In Group 13, Tl should be stable + 1 state than + 3 oxidation state due to inert pair effect.

5. Write the structure of AlCl_3 as a dimer.

Ans. AlCl_3 becomes stable by forming a dimer. The shape of AlCl_3 is tetrahedral.

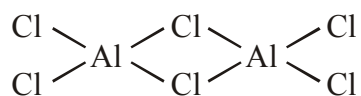

Short Answer Type Questions (4 Marks)

1. **What are electron deficient compounds? Is BCl_3 an electron deficient species? Explain.**

Ans. The compounds in which there are insufficient number of electrons to complete the octet of central atom are called as electron deficient compounds.

Example is BCl_3 . In this molecule (BCl_3) the central atom 'B' accepts electrons from NH_3 and forms BCl_3NH_3 .

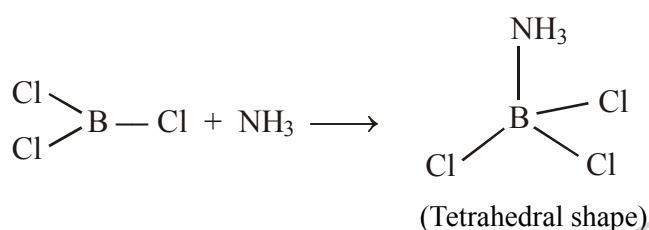

2. **B-Cl bond has a bond moment. Explain why BCl_3 molecule has zero dipole moment.**

Ans. There are two factors that govern the bond moments of a molecule. they are electronegativity values and the geometry or the molecular arrangement in a compound.

(1) B – Cl has a dipole due to the difference in the electronegativity of Boron and Chlorine atoms.

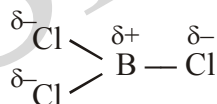

(2) BCl_3 molecule is symmetrical in structure with trigonal planar in shape and with a bond angle of 120° .

(3) In BCl_3 molecule, the resultant of two B – Cl bonds is cancelled by the third B – Cl Bond.

(4) Hence BCl_3 molecule has zero dipole moment.

p-Block Elements - Group 14**Very Short Answer Type Questions (2 Marks)**

1. Give the Hybridisation of Carbon in

(a) CO_3^{2-} (b) Diamond (c) Graphite (d) Fullerene.

Ans. (a) In CO_3^{2-} , Carbon shows sp^3 hybridisation.

(b) In Diamond, Carbon shows sp^3 hybridization.

(c) In graphite, Carbon shows sp^2 hybridization.

(d) In fullerene, Carbon shows sp^2 hybridization.

2. Why is CO poisonous?

Ans. Carbon monoxide (CO) has the capacity to mix with haemoglobin molecules in blood and forms a complex with haemoglobin which is 300 times more stable than the oxygen = Haemoglobin complex. This prevents haemoglobin from carrying O_2 to different parts of the body and results in death. Hence, CO is highly poisonous in nature.

3. What is allotropy? Give the Crystalline allotropes of Carbon.

Ans. The tendency of an element to exist in two or more forms with same chemical properties is called as allotropy.

Crystalline allotropes of Carbon:

(1) Diamond (2) Graphite (3) Fullerene.

4. Write the outer electronic configuration of group-14 elements.

Ans. The outer electronic configuration of group 14 elements is ns^2np^2 .

Carbon - $[\text{He}] 2s^2sp^2$

Silicon - $[\text{Ne}] 3s^2sp^2$

Germanium - $[\text{Ar}] 3d^{10}4s^24p^2$

Tin - $[\text{Kr}] 4d^{10}5s^25p^2$

Lead - $[\text{Xe}] 4f^{14}5d^{10}6s^26p^2$

5. How does graphite function as a lubricant?

Ans. Graphite has layer like structure. These layers can slide easily one over the other due to weak vander woods forces. Hence graphite is very soft and slippery in nature and used as a dry lubricant in machines which run at high temperature.

6. Graphite is good conductor. Why?

Ans. In graphite each Carbon atom undergoes sp^2 hybridization and has one free p - electron. Due to the presence of these free electrons, graphite behaves as a good conductor or electricity.

7. C - C bond length in graphite is shorter than C - C bond length in Diamond. Explain.

Ans. In Graphite Carbon undergoes sp^2 hybridisation where as in diamond it undergoes sp^3 hybridisation. So, the C - C bond length is 141.5 pm in graphite and 154 pm in Diamond. Hence, the C - C bond length in graphite is shorter than the C - C bond length in Diamond.

Short Answer Type Questions (4 Marks)**8. Explain the difference in properties of Diamond and Graphite on the basis of their structure.**

Ans.	Diamond	Graphite
1.	Carbon undergoes sp^3 hybridization	1. Carbon undergoes sp^2 hybridization
2.	It has three dimensional structure.	2. It has two dimensional structure/
3.	It is a bad conductor of electricity.	3. It is a good conductor of electricity.
4.	The C - C bond length of 1.54\AA and bond angle is $109^\circ 28'$	4. The C - C bond length is 1.42\AA and bond angle is 120°
5.	Its density is more.	5. Its density is less.

9. What do you understand by (a) Allotropy (b) Inert Pair effect (c) Catenation.

Ans. **(a) Allotropy:** The ability of a compound to exist in two or more states with different physical but same chemical properties is termed as Allotropy.

Crystalline Allotropes: Diamond, Graphite and fullerenes.

Amorphous Allotropes: Coal, Coke, Wood charcoal, Gas Carbon, Lamp Black.

(b) Inert Pair effect: "The reluctance of 'ns' electrons to participate in bond formation" is known as Inert Pair effect.

Eg: In Group-14, Pb shows +2 stable oxidation state instead of +4 oxidation states due to inert pair effect.

(c) Catenation: The ability of an atom of the same element to form a long chain or group is known as Catenation. The order of Catenation of Group-14 is

$C \gg Si > Ge = Sn$

Pb = No Catenation

Carbon has highest catenation ability due to its high bond energy.

10. Why Diamond is hard?

Ans. Diamond is a Crystalline lattice and forms a three dimensional structure with carbon atoms. Each Carbon atom is linked to four other carbon atoms in a tetrahedral fashion and undergoes sp^3 hybridisation. The C - C bonds are very strong and form directional covalent bonds. To break these bonds, large amount of energy is required. Hence, diamond is hard and can be used as abrasive.

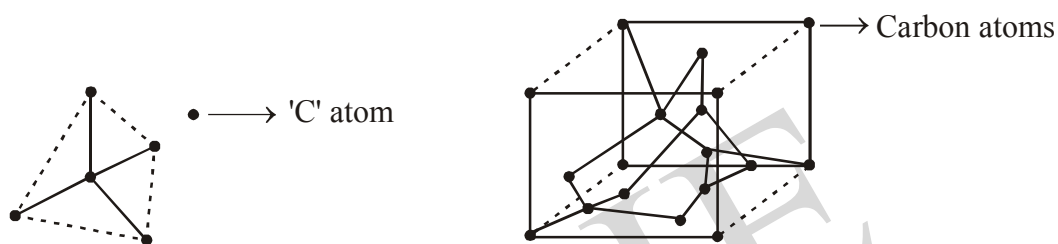

(Anyone figure)

Organic Chemistry - Hydrocarbon and Aromatic Hydrocarbon

Very Short Answer Type Questions (2 Marks)

1. Write the reagents required for conversion of Benzene to Methyl Benzene.

Ans. When Benzene is treated with Methyl Chloride in presence of Anh. AlCl_3 , Methyl Benzene is obtained.

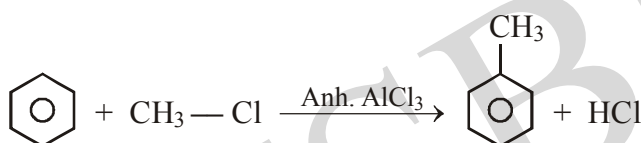

2. How is Nitro Benzene prepared?

Ans. When Benzene reacts with nitration mixture (Conc. HNO_3 + Conc. H_2SO_4) at $<60^\circ\text{C}$. Nitro Benzene is obtained.

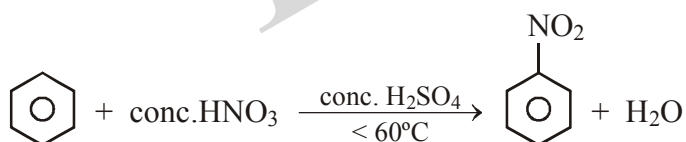

3. Write the confirmations of Ethane.

Ans. There are two confirmations for Ethane. These can be represented by saw-horse or Neoman projection.

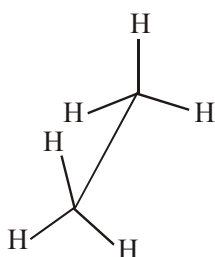

Sawhorse
Projection

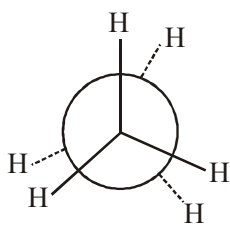

Newman
Projection

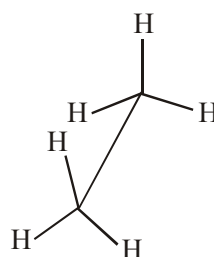

Sawhorse
Projection

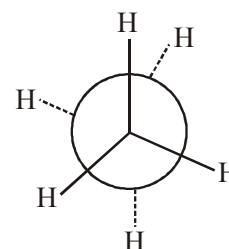

Newman
Projection

4. How do you prepare Ethyl Chloride from Ethylene.

Ans. Ethylene reacts with HCl in presence of Anh. AlCl₃, Ethyl Chloride is obtained.

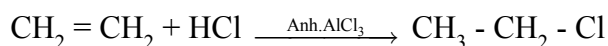

5. Write the IUPAC names of

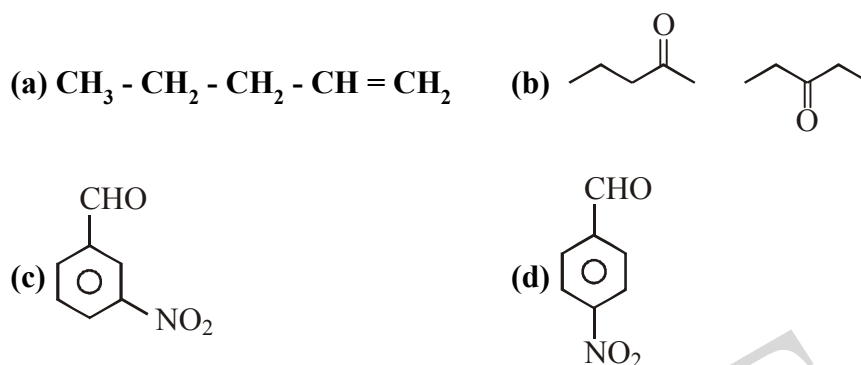

Ans. (a) $\text{CH}_3 - \text{CH}_2 - \text{CH}_2 - \text{CH} = \text{CH}_2 \rightarrow$ Pent-1-ene

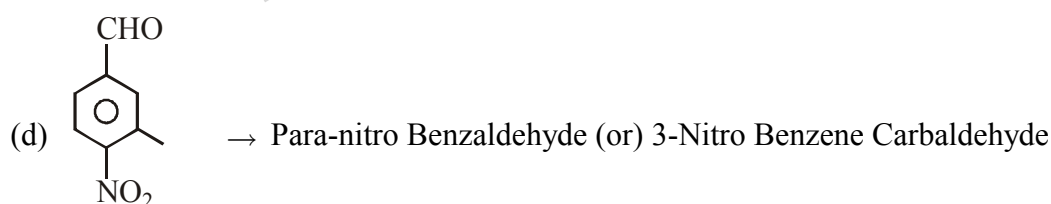
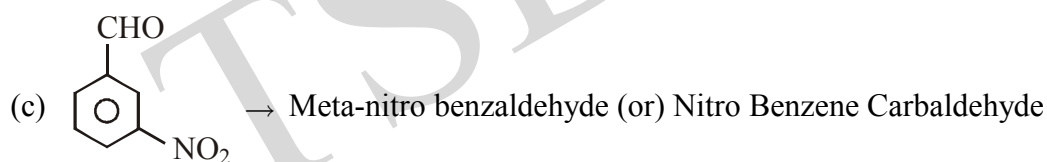
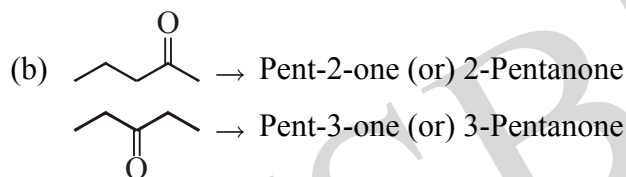

Short Answer Type Questions (4 Marks)

6. Complete the following reactions and the products A, B and C.

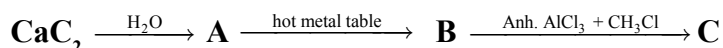

Ans. **Step-1:** $\text{CaC}_2 + 2\text{H}_2\text{O} \rightarrow \text{Ca(OH)}_2 + \text{C}_2\text{H}_2$

A = C_2H_2 = Acetylene

Step-2: $3\text{C}_2\text{H}_2 \xrightarrow{\text{hot metal table}} \text{C}_6\text{H}_6$

B = Benzene = C_6H_6

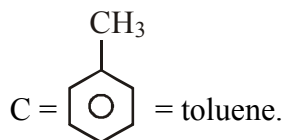
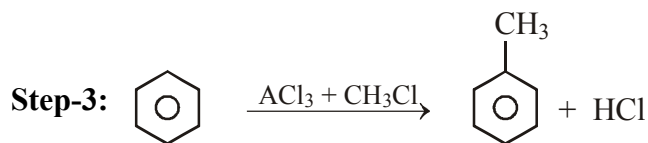

7. Name the products A, B and C formed in the following reactions. Give the equations for the reactions.

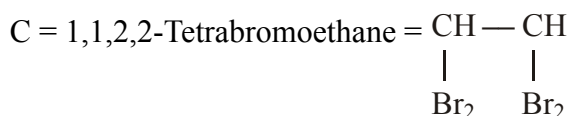
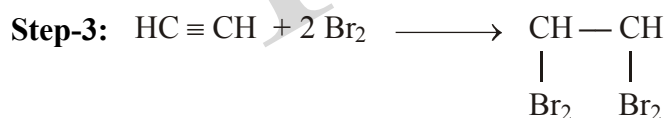
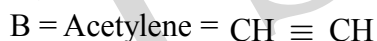
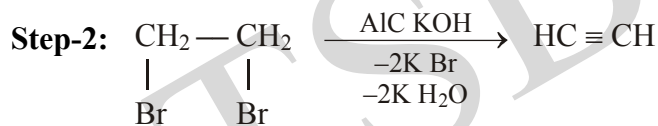
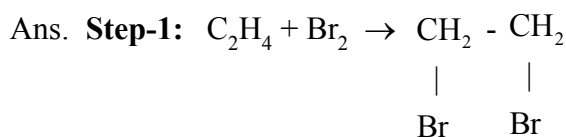

8. How does Acetylene react with (a) Bromine (b) Hydrogen? Write the balanced equations for the above reactions. Name the Products.

Ans. (a) Acetylene reacts with bromine in the presence of carbon tetrachloride and forms 1,1,2,2-Tetrabromoethane as final product.

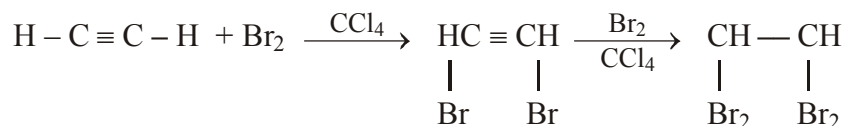

(b) Acetylene reacts with hydrogen in the presence of catalyst and forms Ethane.

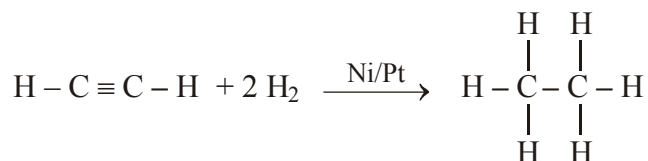

9. What is substitution reaction? Explain any two substitution reactions of Benzene.

Ans. In a reaction, an atom or a group of atoms is replaced by another atom or group then the reaction is known as Substitution reaction.

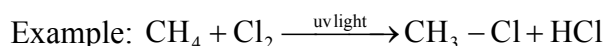

Substitution reactions of Benzene

- (i) **Nitration:** When Benzene is heated with Nitration mixture at $<60^\circ$, Nitro Benzene is obtained.

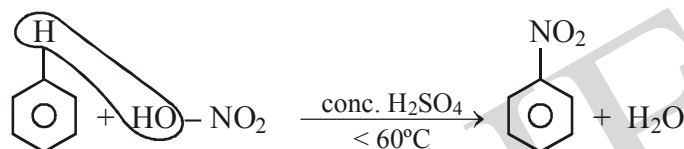

- (ii) **Halogenation:** When Benzene is treated with Cl_2 in presence of Anh. AlCl_3 or Anh. FeCl_3 , Chlorobenzene is obtained.



10. What is dehydro halogenation? Write the equation for the formation of Alkene from Alkyl halide.

Ans. **Dehydrohalogenation:** The process of removing one hydrogen atom and one halogen atom from adjacent carbon atoms of an Alkylhalide in the presence of a base to form an Alkene is known as dehydrohalogenation.

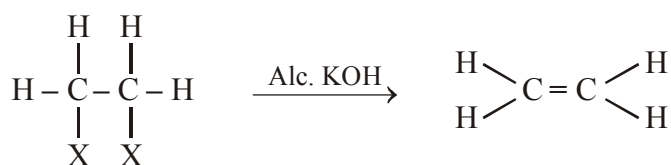

11. Give two examples each for position and functional Isomerism.

Ans. (1) **Position Isomerism:** Isomers which have the same molecular formula but differ in the position of particular atom or a group or a multiple bond on the carbon chain; then the isomers are called position isomers and the phenomenon position Isomerism

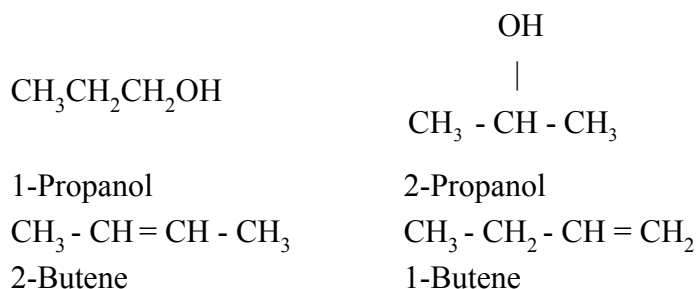

- (2) **Functional Group Isomersim:** Two isomers which have same molecular formula but differ in the nature of functional group are known as functional isomers and the phenomenon functional group Isomerism.

Example:

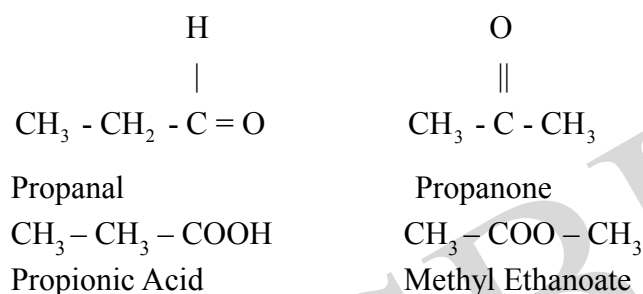

12. **What is the product formed when Sodium propionate is heated with Soda lime.**

Ans. When Sodium propionate is heated with Sodalime, it produces Ethane.

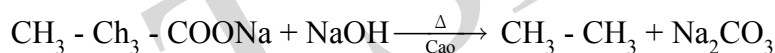

13. **Write the IUPAC names of the following compounds.**

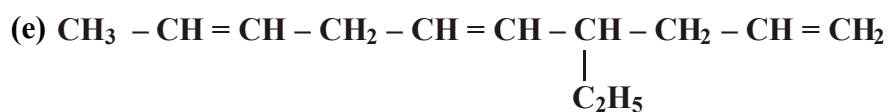
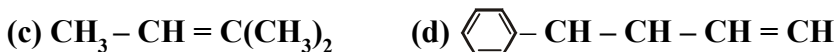
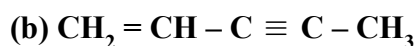

Ans: (a) \rightarrow 1, 3 - Butadiene

(b) $\text{CH}_2 = \text{CH} - \text{C} \equiv \text{C} - \text{CH}_3 \rightarrow$ Pent-1-ene-3-yne

(c) $\text{CH}_3 - \text{CH} = \text{C}(\text{CH}_3)_2 \rightarrow$ 2-Methyl-2-Butene

(d) \rightarrow 4-Phenyl-1-Butene

(e) $\text{CH}_3 - \text{CH} = \text{CH} - \text{CH}_2 - \text{CH} = \text{CH} - \underset{\text{C}_2\text{H}_5}{\text{CH}} - \text{CH}_2 - \text{CH} = \text{CH}_2$

\rightarrow 4 - Ethyl - 1, 5, 8 - decatriene.

14. How does ethylene react with the following reagents? Give the chemical equation and names of the products formed in the reactions.

(a) Hydrogenhalide (b) Hydrogen (c) Bromine (d) Water

Ans. (a) **Hydrogehalide:** Ethylene reacts with hydrogenhalides (HCl, HBr or HI) and gives Ethylhalides

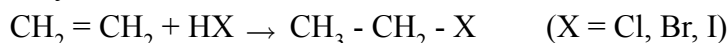

(b) **H₂:** Ethylene reacts with hydrogen in the presence of Nickel or Platinum or Palladium Catalyst and gives Ethane.

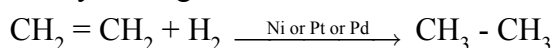

(b) **Br₂:** Ethylene reacts with bromine in presence of CCl₄ and gives 1, 2 - dibromoethane.

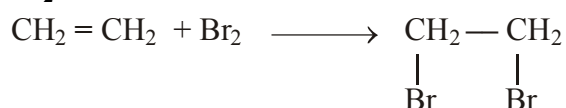

(c) **H₂O:** Ethylene reacts with water in presence of Conc.H₂SO₄ and gives ethanol or Ethyl alcohol.



15. How do we get Benzene from Acetylene? Give the corresponding equation. Explain the halogenations, Alkylation, Acetylation, Nitration and Sulphonation of Benzene.

Ans. **Preparation of Benzene:** Acetylene undergoes cyclic polymetisation when passed through Red hot Iron tube at 873k. Three molecules of Acetylene Polymerise to form Benzene.



Reactions of Benzene: (Electrophilic Substitution Reactions)

(1) **Halogenation:** The proces in which Benzene is treated with halogens producing halobenzene in presence of Lewis Acid Anh.FeCl₃, Anh.AlCl₃

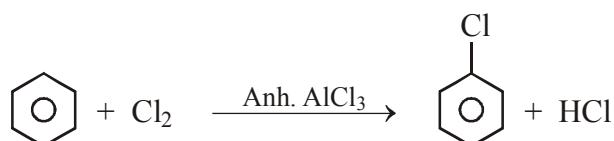

(2) **Alkylation:** It is also known as Friedel Crafts alkylation. Benzene reacts with alkyl halides in the presence of Anhydrous AlCl₃ and give Alkyl benzene or Toluene.

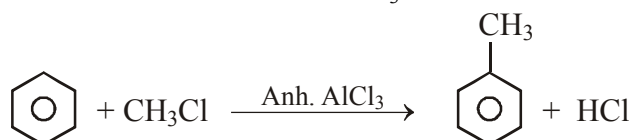

(3) **Acylation:** It is also known as Friedel Crafts acylation. Benzene reacts with Acylhalides in the presence of Lewis acid (And. AlCl₃) and gives Acyl benzene (or) Acyl Arene.

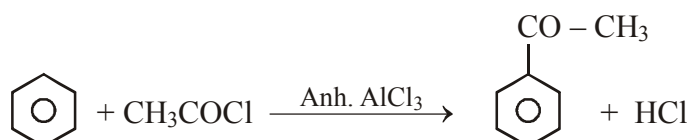

- (4) **Reaction with Nitration mixture:** The reaction is commonly called as nitration. Benzene reacts with a mixture of Conc. HNO_3 and Conc. H_2SO_4 and give Nitro benzene.

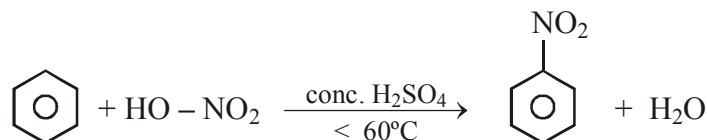

- (5) **Reaction with Sulphuric Acid:** It is also known as Sulphanation. When Benzene is heated with Oleum, Benzene sulphonic Acid is formed.

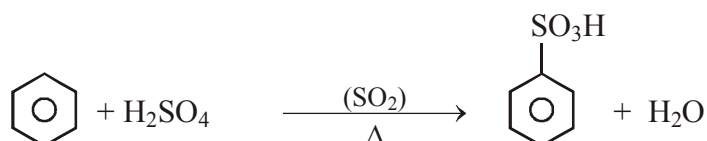

16. What do you understand about Geometrical Isomerism? Explain the geometrical isomers of 2 - Butene.

Ans. The isomers which have the same structural formula but differ in spatial arrangement of atoms or groups around the double bond are known as geometrical isomers and the phenomenon is known as geometrical isomerism. It is also known as Cis-Trans Isomerism.

Eg: 2-Butene will exhibit two geometrical isomers.



17. Discuss Markovnikov Rule and Kharash effect.

Ans. **Markovnikov Rule:** When unsymmetrical Alkene is treated with HX ($\text{X} = \text{Cl}, \text{Br}, \text{I}$), the negative part of the reagent is added to Carbon having less number of 'H' atoms.

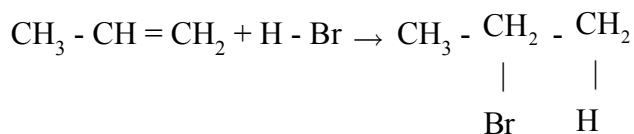

Propene 2 - Bromopropane

Kharash Effect: When unsymmetrical Alkene ($\text{CH}_3 - \text{CH} = \text{CH}_2$) is treated with HX ($\text{X} = \text{Cl}, \text{Br}, \text{I}$) in presence of Peroxide, the negative part of the reagent is added to the Carbon having more number of hydrogen atoms.

