

SECTION 1 (Maximum Marks: 18)

- This section contains **SIX (06)** questions.
- The answer to each question is a **SINGLE DIGIT INTEGER** ranging from **0 TO 9, BOTH INCLUSIVE**.
- For each question, enter the correct integer corresponding to the answer using the mouse and the on-screen virtual numeric keypad in the place designated to enter the answer.
- Answer to each question will be evaluated according to the following marking scheme:
Full Marks : +3 If **ONLY** the correct integer is entered;
Zero Marks : 0 If the question is unanswered;
Negative Marks : -1 In all other cases.

Q.1 A large square container with thin transparent vertical walls and filled with water (refractive index $\frac{4}{3}$) is kept on a horizontal table. A student holds a thin straight wire vertically inside the water 12 cm from one of its corners, as shown schematically in the figure. Looking at the wire from this corner, another student sees two images of the wire, located symmetrically on each side of the line of sight as shown. The separation (in cm) between these images is _____.

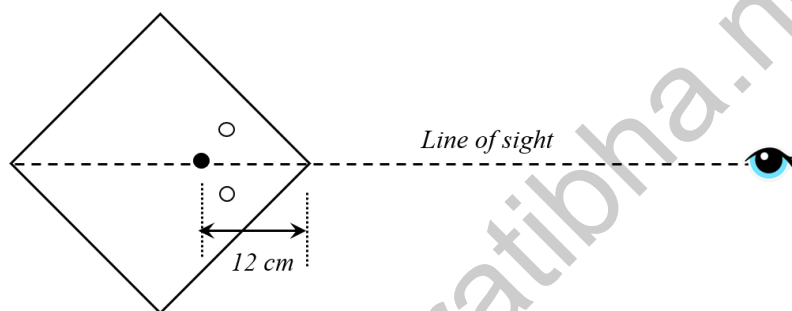

Q.2 A train with cross-sectional area S_t is moving with speed v_t inside a long tunnel of cross-sectional area S_0 ($S_0 = 4S_t$). Assume that almost all the air (density ρ) in front of the train flows back between its sides and the walls of the tunnel. Also, the air flow with respect to the train is steady and laminar. Take the ambient pressure and that inside the train to be p_0 . If the pressure in the region between the sides of the train and the tunnel walls is p , then $p_0 - p = \frac{7}{2N} \rho v_t^2$. The value of N is _____.

- Q.3 Two large circular discs separated by a distance of 0.01 m are connected to a battery via a switch as shown in the figure. Charged oil drops of density 900 kg m^{-3} are released through a tiny hole at the center of the top disc. Once some oil drops achieve terminal velocity, the switch is closed to apply a voltage of 200 V across the discs. As a result, an oil drop of radius $8 \times 10^{-7} \text{ m}$ stops moving vertically and floats between the discs. The number of electrons present in this oil drop is _____. (neglect the buoyancy force, take acceleration due to gravity = 10 ms^{-2} and charge on an electron (e) = $1.6 \times 10^{-19} \text{ C}$)

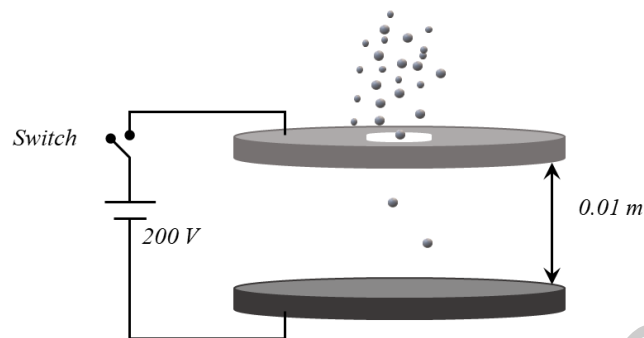

- Q.4 A hot air balloon is carrying some passengers, and a few sandbags of mass 1 kg each so that its total mass is 480 kg. Its effective volume giving the balloon its buoyancy is V . The balloon is floating at an equilibrium height of 100 m. When N number of sandbags are thrown out, the balloon rises to a new equilibrium height close to 150 m with its volume V remaining unchanged. If the variation of the density of air with height h from the ground is $\rho(h) = \rho_0 e^{-\frac{h}{h_0}}$, where $\rho_0 = 1.25 \text{ kg m}^{-3}$ and $h_0 = 6000 \text{ m}$, the value of N is _____.

- Q.5 A point charge q of mass m is suspended vertically by a string of length l . A point dipole of dipole moment \vec{p} is now brought towards q from infinity so that the charge moves away. The final equilibrium position of the system including the direction of the dipole, the angles and distances is shown in the figure below. If the work done in bringing the dipole to this position is $N \times (mgh)$, where g is the acceleration due to gravity, then the value of N is _____. (Note that for three coplanar forces keeping a point mass in equilibrium, $\frac{F}{\sin\theta}$ is the same for all forces, where F is any one of the forces and θ is the angle between the other two forces)

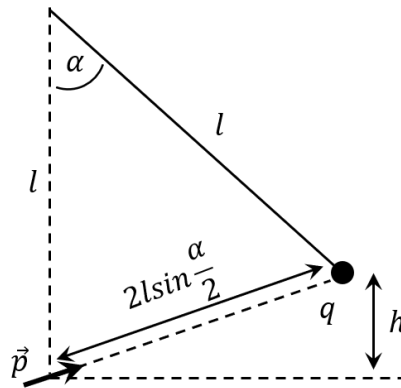

- Q.6 A thermally isolated cylindrical closed vessel of height 8 m is kept vertically. It is divided into two equal parts by a diathermic (perfect thermal conductor) frictionless partition of mass 8.3 kg. Thus the partition is held initially at a distance of 4 m from the top, as shown in the schematic figure below. Each of the two parts of the vessel contains 0.1 mole of an ideal gas at temperature 300 K. The partition is now released and moves without any gas leaking from one part of the vessel to the other. When equilibrium is reached, the distance of the partition from the top (in m) will be _____ (take the acceleration due to gravity = 10 ms^{-2} and the universal gas constant = $8.3 \text{ J mol}^{-1} \text{ K}^{-1}$).

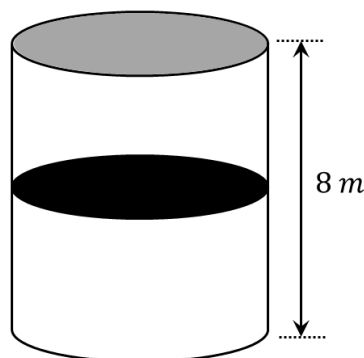

SECTION 2 (Maximum Marks: 24)

- This section contains **SIX (06)** questions.
- Each question has **FOUR** options. **ONE OR MORE THAN ONE** of these four option(s) is(are) correct answer(s).
- For each question, choose the option(s) corresponding to (all) the correct answer(s).
- Answer to each question will be evaluated according to the following marking scheme:
 - Full Marks* : +4 If only (all) the correct option(s) is(are) chosen;
 - Partial Marks* : +3 If all the four options are correct but ONLY three options are chosen;
 - Partial Marks* : +2 If three or more options are correct but ONLY two options are chosen, both of which are correct;
 - Partial Marks* : +1 If two or more options are correct but ONLY one option is chosen and it is a correct option;
 - Zero Marks* : 0 If none of the options is chosen (i.e. the question is unanswered);
 - Negative Marks* : -2 In all other cases.

- Q.7 A beaker of radius r is filled with water (refractive index $\frac{4}{3}$) up to a height H as shown in the figure on the left. The beaker is kept on a horizontal table rotating with angular speed ω . This makes the water surface curved so that the difference in the height of water level at the center and at the circumference of the beaker is h ($h \ll H$, $h \ll r$), as shown in the figure on the right. Take this surface to be approximately spherical with a radius of curvature R . Which of the following is/are correct? (g is the acceleration due to gravity)

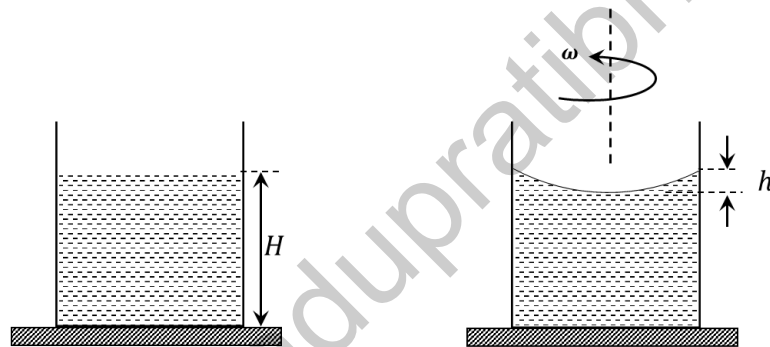

- (A) $R = \frac{h^2 + r^2}{2h}$
- (B) $R = \frac{3r^2}{2h}$
- (C) Apparent depth of the bottom of the beaker is close to $\frac{3H}{2} \left(1 + \frac{\omega^2 H}{2g}\right)^{-1}$
- (D) Apparent depth of the bottom of the beaker is close to $\frac{3H}{4} \left(1 + \frac{\omega^2 H}{4g}\right)^{-1}$

- Q.8 A student skates up a ramp that makes an angle 30° with the horizontal. He/she starts (as shown in the figure) at the bottom of the ramp with speed v_0 and wants to turn around over a semicircular path xyz of radius R during which he/she reaches a maximum height h (at point y) from the ground as shown in the figure. Assume that the energy loss is negligible and the force required for this turn at the highest point is provided by his/her weight only. Then (g is the acceleration due to gravity)

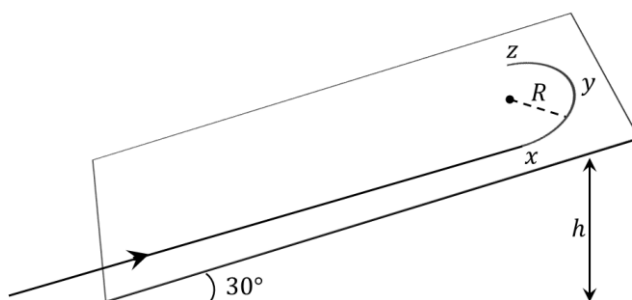

- (A) $v_0^2 - 2gh = \frac{1}{2}gR$
 (B) $v_0^2 - 2gh = \frac{\sqrt{3}}{2}gR$
 (C) the centripetal force required at points x and z is zero
 (D) the centripetal force required is maximum at points x and z
- Q.9 A rod of mass m and length L , pivoted at one of its ends, is hanging vertically. A bullet of the same mass moving at speed v strikes the rod horizontally at a distance x from its pivoted end and gets embedded in it. The combined system now rotates with angular speed ω about the pivot. The maximum angular speed ω_M is achieved for $x = x_M$. Then

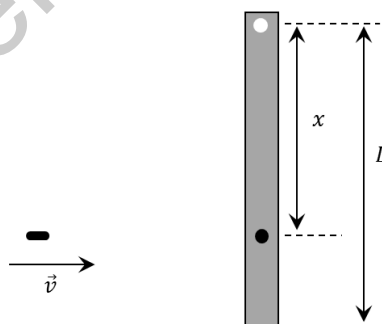

- (A) $\omega = \frac{3vx}{L^2 + 3x^2}$
 (B) $\omega = \frac{12vx}{L^2 + 12x^2}$
 (C) $x_M = \frac{L}{\sqrt{3}}$
 (D) $\omega_M = \frac{v}{2L}\sqrt{3}$

- Q.10 In an X-ray tube, electrons emitted from a filament (cathode) carrying current I hit a target (anode) at a distance d from the cathode. The target is kept at a potential V higher than the cathode resulting in emission of continuous and characteristic X-rays. If the filament current I is decreased to $\frac{I}{2}$, the potential difference V is increased to $2V$, and the separation distance d is reduced to $\frac{d}{2}$, then
- (A) the cut-off wavelength will reduce to half, and the wavelengths of the characteristic X-rays will remain the same
 - (B) the cut-off wavelength as well as the wavelengths of the characteristic X-rays will remain the same
 - (C) the cut-off wavelength will reduce to half, and the intensities of all the X-rays will decrease
 - (D) the cut-off wavelength will become two times larger, and the intensity of all the X-rays will decrease

www.eenadupratibha.net

- Q.11 Two identical non-conducting solid spheres of same mass and charge are suspended in air from a common point by two non-conducting, massless strings of same length. At equilibrium, the angle between the strings is α . The spheres are now immersed in a dielectric liquid of density 800 kg m^{-3} and dielectric constant 21. If the angle between the strings remains the same after the immersion, then
- (A) electric force between the spheres remains unchanged
 - (B) electric force between the spheres reduces
 - (C) mass density of the spheres is 840 kg m^{-3}
 - (D) the tension in the strings holding the spheres remains unchanged
- Q.12 Starting at time $t = 0$ from the origin with speed 1 ms^{-1} , a particle follows a two-dimensional trajectory in the x - y plane so that its coordinates are related by the equation $y = \frac{x^2}{2}$. The x and y components of its acceleration are denoted by a_x and a_y , respectively. Then
- (A) $a_x = 1 \text{ ms}^{-2}$ implies that when the particle is at the origin, $a_y = 1 \text{ ms}^{-2}$
 - (B) $a_x = 0$ implies $a_y = 1 \text{ ms}^{-2}$ at all times
 - (C) at $t = 0$, the particle's velocity points in the x -direction
 - (D) $a_x = 0$ implies that at $t = 1 \text{ s}$, the angle between the particle's velocity and the x axis is 45°

SECTION 3 (Maximum Marks: 24)

- This section contains **SIX (06)** questions. The answer to each question is a **NUMERICAL VALUE**.
- For each question, enter the correct numerical value of the answer using the mouse and the on-screen virtual numeric keypad in the place designated to enter the answer. If the numerical value has more than two decimal places, **truncate/round-off** the value to **TWO** decimal places.
- Answer to each question will be evaluated according to the following marking scheme:
Full Marks : +4 If ONLY the correct numerical value is entered;
Zero Marks : 0 In all other cases.

- Q.13 A spherical bubble inside water has radius R . Take the pressure inside the bubble and the water pressure to be p_0 . The bubble now gets compressed radially in an adiabatic manner so that its radius becomes $(R - a)$. For $a \ll R$ the magnitude of the work done in the process is given by $(4\pi p_0 R a^2)X$, where X is a constant and $\gamma = C_p/C_V = 41/30$. The value of X is _____.
- Q.14 In the balanced condition, the values of the resistances of the four arms of a Wheatstone bridge are shown in the figure below. The resistance R_3 has temperature coefficient $0.0004\text{ }^\circ\text{C}^{-1}$. If the temperature of R_3 is increased by $100\text{ }^\circ\text{C}$, the voltage developed between S and T will be _____ volt.

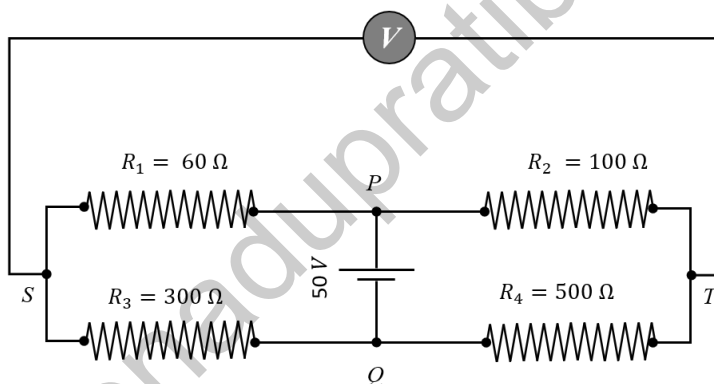

- Q.15 Two capacitors with capacitance values $C_1 = 2000 \pm 10\text{ pF}$ and $C_2 = 3000 \pm 15\text{ pF}$ are connected in series. The voltage applied across this combination is $V = 5.00 \pm 0.02\text{ V}$. The percentage error in the calculation of the energy stored in this combination of capacitors is _____.
- Q.16 A cubical solid aluminium (bulk modulus $= -V \frac{dP}{dV} = 70\text{ GPa}$) block has an edge length of 1 m on the surface of the earth. It is kept on the floor of a 5 km deep ocean. Taking the average density of water and the acceleration due to gravity to be 10^3 kg m^{-3} and 10 ms^{-2} , respectively, the change in the edge length of the block in mm is _____.

- Q.17 The inductors of two LR circuits are placed next to each other, as shown in the figure. The values of the self-inductance of the inductors, resistances, mutual-inductance and applied voltages are specified in the given circuit. After both the switches are closed simultaneously, the total work done by the batteries against the induced EMF in the inductors by the time the currents reach their steady state values is _____ mJ.

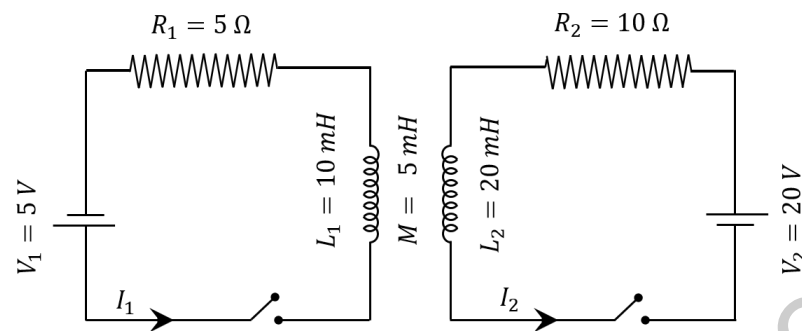

- Q.18 A container with 1 kg of water in it is kept in sunlight, which causes the water to get warmer than the surroundings. The average energy per unit time per unit area received due to the sunlight is 700 Wm^{-2} and it is absorbed by the water over an effective area of 0.05 m^2 . Assuming that the heat loss from the water to the surroundings is governed by Newton's law of cooling, the difference (in $^{\circ}\text{C}$) in the temperature of water and the surroundings after a long time will be _____. (Ignore effect of the container, and take constant for Newton's law of cooling = 0.001 s^{-1} , Heat capacity of water = $4200 \text{ J kg}^{-1} \text{ K}^{-1}$)

END OF THE QUESTION PAPER

SECTION 1 (Maximum Marks: 18)

- This section contains **SIX (06)** questions.
- The answer to each question is a **SINGLE DIGIT INTEGER** ranging from **0 TO 9, BOTH INCLUSIVE**.
- For each question, enter the correct integer corresponding to the answer using the mouse and the on-screen virtual numeric keypad in the place designated to enter the answer.
- Answer to each question will be evaluated according to the following marking scheme:
Full Marks : +3 If ONLY the correct integer is entered;
Zero Marks : 0 If the question is unanswered;
Negative Marks : -1 In all other cases.

- Q.1 The 1st, 2nd, and the 3rd ionization enthalpies, I_1 , I_2 , and I_3 , of four atoms with atomic numbers n , $n + 1$, $n + 2$, and $n + 3$, where $n < 10$, are tabulated below. What is the value of n ?

Atomic number	Ionization Enthalpy (kJ/mol)		
	I_1	I_2	I_3
n	1681	3374	6050
$n + 1$	2081	3952	6122
$n + 2$	496	4562	6910
$n + 3$	738	1451	7733

- Q.2 Consider the following compounds in the liquid form:
 O_2 , HF, H_2O , NH_3 , H_2O_2 , CCl_4 , $CHCl_3$, C_6H_6 , C_6H_5Cl .

When a charged comb is brought near their flowing stream, how many of them show deflection as per the following figure?

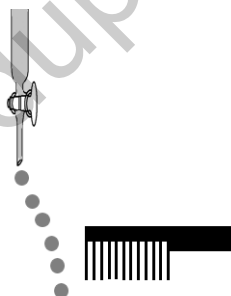

- Q.3 In the chemical reaction between stoichiometric quantities of $KMnO_4$ and KI in weakly basic solution, what is the number of moles of I_2 released for 4 moles of $KMnO_4$ consumed?
- Q.4 An acidified solution of potassium chromate was layered with an equal volume of amyl alcohol. When it was shaken after the addition of 1 mL of 3% H_2O_2 , a blue alcohol layer was obtained. The blue color is due to the formation of a chromium (VI) compound 'X'. What is the number of oxygen atoms bonded to chromium through only single bonds in a molecule of X?

Q.5 The structure of a peptide is given below.

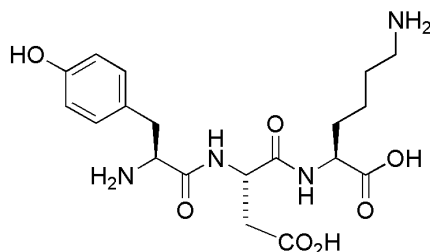

If the absolute values of the net charge of the peptide at $\text{pH} = 2$, $\text{pH} = 6$, and $\text{pH} = 11$ are $|z_1|$, $|z_2|$, and $|z_3|$, respectively, then what is $|z_1| + |z_2| + |z_3|$?

Q.6 An organic compound ($\text{C}_8\text{H}_{10}\text{O}_2$) rotates plane-polarized light. It produces pink color with neutral FeCl_3 solution. What is the total number of all the possible isomers for this compound?

SECTION 2 (Maximum Marks: 24)

- This section contains **SIX (06)** questions.
- Each question has **FOUR** options. **ONE OR MORE THAN ONE** of these four option(s) is(are) correct answer(s).
- For each question, choose the option(s) corresponding to (all) the correct answer(s).
- Answer to each question will be evaluated according to the following marking scheme:
 - Full Marks* : +4 If only (all) the correct option(s) is(are) chosen;
 - Partial Marks* : +3 If all the four options are correct but **ONLY** three options are chosen;
 - Partial Marks* : +2 If three or more options are correct but **ONLY** two options are chosen, both of which are correct;
 - Partial Marks* : +1 If two or more options are correct but **ONLY** one option is chosen and it is a correct option;
 - Zero Marks* : 0 If none of the options is chosen (i.e. the question is unanswered);
 - Negative Marks* : -2 In all other cases.

- Q.7 In an experiment, m grams of a compound **X** (gas/liquid/solid) taken in a container is loaded in a balance as shown in figure **I** below. In the presence of a magnetic field, the pan with **X** is either deflected upwards (figure **II**), or deflected downwards (figure **III**), depending on the compound **X**. Identify the correct statement(s).

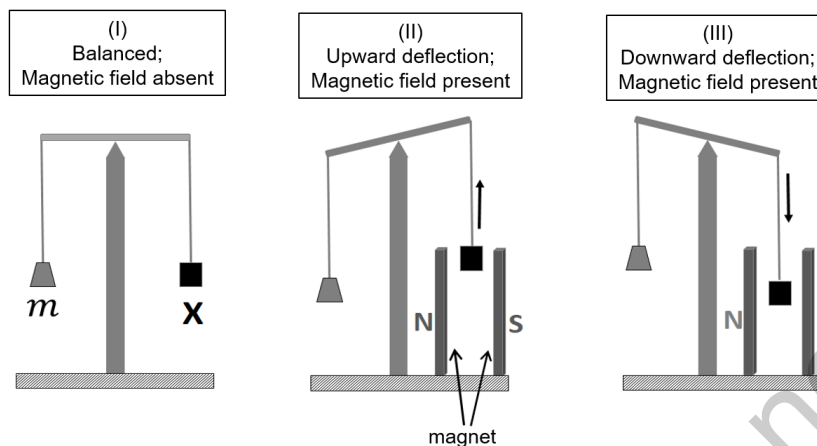

- (A) If **X** is $\text{H}_2\text{O}(l)$, deflection of the pan is upwards.
(B) If **X** is $\text{K}_4[\text{Fe}(\text{CN})_6](s)$, deflection of the pan is upwards.
(C) If **X** is $\text{O}_2(g)$, deflection of the pan is downwards.
(D) If **X** is $\text{C}_6\text{H}_6(l)$, deflection of the pan is downwards.

- Q.8 Which of the following plots is(are) correct for the given reaction?
 ($[P]_0$ is the initial concentration of **P**)

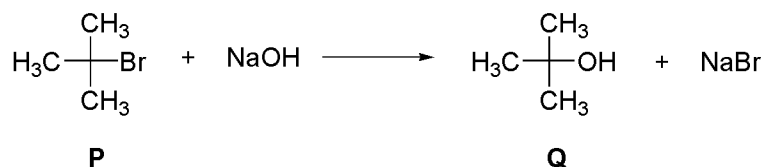

(A)

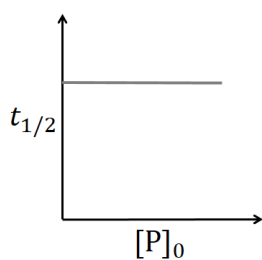

(B)

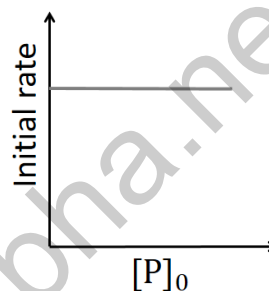

(C)

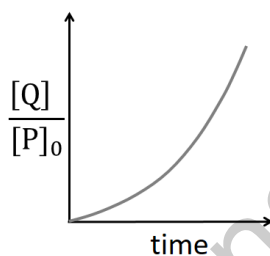

(D)

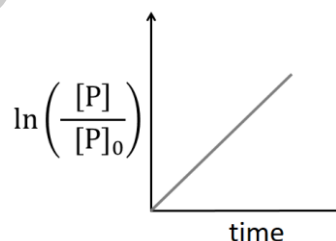

- Q.9 Which among the following statement(s) is(are) true for the extraction of aluminium from bauxite?

- (A) Hydrated Al_2O_3 precipitates, when CO_2 is bubbled through a solution of sodium aluminate.
 (B) Addition of Na_3AlF_6 lowers the melting point of alumina.
 (C) CO_2 is evolved at the anode during electrolysis.
 (D) The cathode is a steel vessel with a lining of carbon.

- Q.10 Choose the correct statement(s) among the following.

- (A) $\text{SnCl}_2 \cdot 2\text{H}_2\text{O}$ is a reducing agent.
 (B) SnO_2 reacts with KOH to form $\text{K}_2[\text{Sn}(\text{OH})_6]$.
 (C) A solution of PbCl_2 in HCl contains Pb^{2+} and Cl^- ions.
 (D) The reaction of Pb_3O_4 with hot dilute nitric acid to give PbO_2 is a redox reaction.

Q.11 Consider the following four compounds **I**, **II**, **III**, and **IV**.

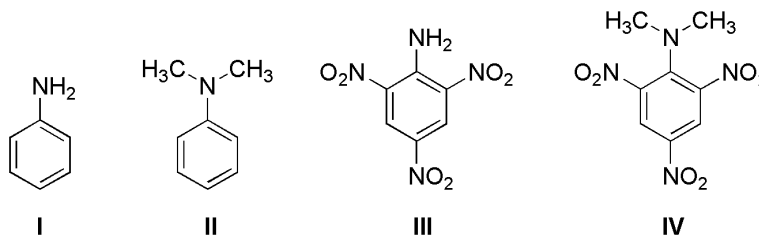

Choose the correct statement(s).

- (A) The order of basicity is **II** > **I** > **III** > **IV**.
 (B) The magnitude of pK_b difference between **I** and **II** is more than that between **III** and **IV**.
 (C) Resonance effect is more in **III** than in **IV**.
 (D) Steric effect makes compound **IV** more basic than **III**.

Q.12 Consider the following transformations of a compound **P**.

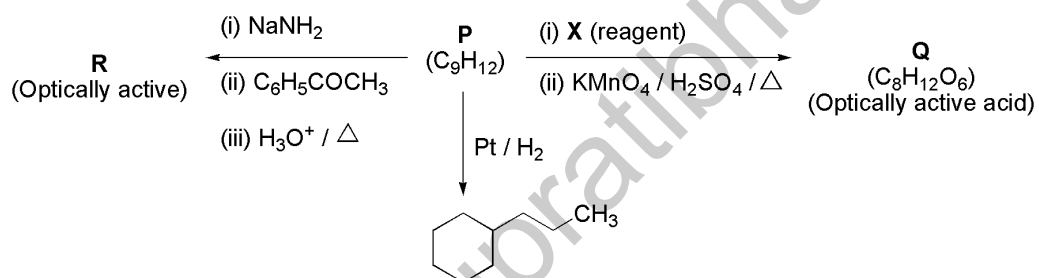

Choose the correct option(s).

(A) **P** is

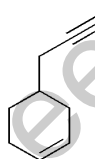

(B) **X** is

Pd-C/quinoline/ H_2

(C) **P** is

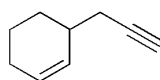

(D) **R** is

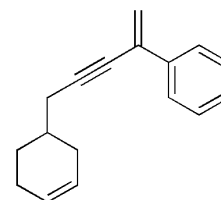

SECTION 3 (Maximum Marks: 24)

- This section contains **SIX (06)** questions. The answer to each question is a **NUMERICAL VALUE**.
- For each question, enter the correct numerical value of the answer using the mouse and the on-screen virtual numeric keypad in the place designated to enter the answer. If the numerical value has more than two decimal places, **truncate/round-off** the value to **TWO** decimal places.
- Answer to each question will be evaluated according to the following marking scheme:
Full Marks : +4 If **ONLY** the correct numerical value is entered;
Zero Marks : 0 In all other cases.

- Q.13 A solution of 0.1 M weak base (B) is titrated with 0.1 M of a strong acid (HA). The variation of pH of the solution with the volume of HA added is shown in the figure below. What is the pK_b of the base? The neutralization reaction is given by $B + HA \rightarrow BH^+ + A^-$.

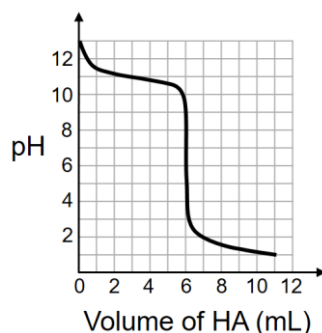

- Q.14 Liquids **A** and **B** form ideal solution for all compositions of **A** and **B** at 25 °C. Two such solutions with 0.25 and 0.50 mole fractions of **A** have the total vapor pressures of 0.3 and 0.4 bar, respectively. What is the vapor pressure of pure liquid **B** in bar?
- Q.15 The figure below is the plot of potential energy versus internuclear distance (d) of H_2 molecule in the electronic ground state. What is the value of the net potential energy E_0 (as indicated in the figure) in kJ mol^{-1} , for $d = d_0$ at which the electron-electron repulsion and the nucleus-nucleus repulsion energies are absent? As reference, the potential energy of H atom is taken as zero when its electron and the nucleus are infinitely far apart. Use Avogadro constant as $6.023 \times 10^{23} \text{ mol}^{-1}$.

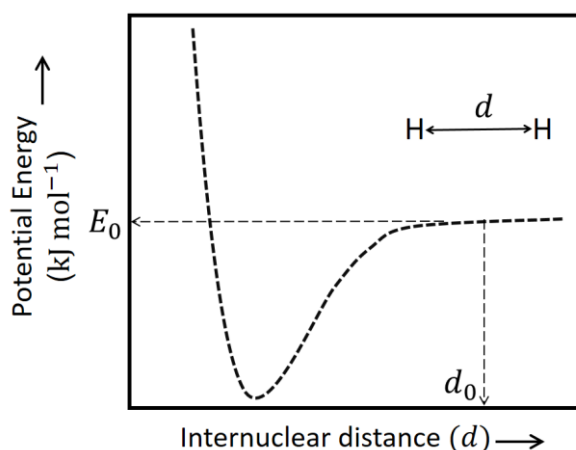

- Q.16 Consider the reaction sequence from **P** to **Q** shown below. The overall yield of the major product **Q** from **P** is 75%. What is the amount in grams of **Q** obtained from 9.3 mL of **P**? (Use density of **P** = 1.00 g mL^{-1} ; Molar mass of C = 12.0, H = 1.0, O = 16.0 and N = 14.0 g mol^{-1})

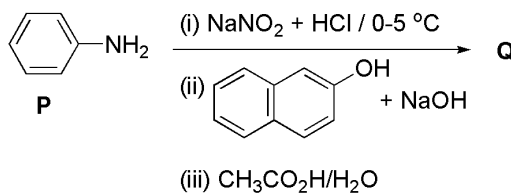

- Q.17 Tin is obtained from cassiterite by reduction with coke. Use the data given below to determine the minimum temperature (in K) at which the reduction of cassiterite by coke would take place.
 At 298 K: $\Delta_f H^\circ(\text{SnO}_2(s)) = -581.0 \text{ kJ mol}^{-1}$, $\Delta_f H^\circ(\text{CO}_2(g)) = -394.0 \text{ kJ mol}^{-1}$,
 $S^\circ(\text{SnO}_2(s)) = 56.0 \text{ J K}^{-1}\text{mol}^{-1}$, $S^\circ(\text{Sn}(s)) = 52.0 \text{ J K}^{-1}\text{mol}^{-1}$,
 $S^\circ(\text{C}(s)) = 6.0 \text{ J K}^{-1}\text{mol}^{-1}$, $S^\circ(\text{CO}_2(g)) = 210.0 \text{ J K}^{-1}\text{mol}^{-1}$.
 Assume that the enthalpies and the entropies are temperature independent.
- Q.18 An acidified solution of 0.05 M Zn^{2+} is saturated with 0.1 M H_2S . What is the minimum molar concentration (M) of H^+ required to prevent the precipitation of ZnS ?
 Use $K_{\text{sp}}(\text{ZnS}) = 1.25 \times 10^{-22}$ and
 overall dissociation constant of H_2S , $K_{\text{NET}} = K_1 K_2 = 1 \times 10^{-21}$.

END OF THE QUESTION PAPER

SECTION 1 (Maximum Marks: 18)

- This section contains **SIX (06)** questions.
- The answer to each question is a **SINGLE DIGIT INTEGER** ranging from **0 TO 9, BOTH INCLUSIVE**.
- For each question, enter the correct integer corresponding to the answer using the mouse and the on-screen virtual numeric keypad in the place designated to enter the answer.
- Answer to each question will be evaluated according to the following marking scheme:
Full Marks : +3 If **ONLY** the correct integer is entered;
Zero Marks : 0 If the question is unanswered;
Negative Marks : -1 In all other cases.

Q.1 For a complex number z , let $\operatorname{Re}(z)$ denote the real part of z . Let S be the set of all complex numbers z satisfying $z^4 - |z|^4 = 4i z^2$, where $i = \sqrt{-1}$. Then the minimum possible value of $|z_1 - z_2|^2$, where $z_1, z_2 \in S$ with $\operatorname{Re}(z_1) > 0$ and $\operatorname{Re}(z_2) < 0$, is _____

Q.2 The probability that a missile hits a target successfully is 0.75. In order to destroy the target completely, at least three successful hits are required. Then the minimum number of missiles that have to be fired so that the probability of completely destroying the target is **NOT** less than 0.95, is _____

Q.3 Let O be the centre of the circle $x^2 + y^2 = r^2$, where $r > \frac{\sqrt{5}}{2}$. Suppose PQ is a chord of this circle and the equation of the line passing through P and Q is $2x + 4y = 5$. If the centre of the circumcircle of the triangle OPQ lies on the line $x + 2y = 4$, then the value of r is _____

Q.4 The trace of a square matrix is defined to be the sum of its diagonal entries. If A is a 2×2 matrix such that the trace of A is 3 and the trace of A^3 is -18 , then the value of the determinant of A is _____

Q.5 Let the functions $f: (-1, 1) \rightarrow \mathbb{R}$ and $g: (-1, 1) \rightarrow (-1, 1)$ be defined by

$$f(x) = |2x - 1| + |2x + 1| \quad \text{and} \quad g(x) = x - [x],$$

where $[x]$ denotes the greatest integer less than or equal to x . Let $f \circ g: (-1, 1) \rightarrow \mathbb{R}$ be the composite function defined by $(f \circ g)(x) = f(g(x))$. Suppose c is the number of points in the interval $(-1, 1)$ at which $f \circ g$ is **NOT** continuous, and suppose d is the number of points in the interval $(-1, 1)$ at which $f \circ g$ is **NOT** differentiable. Then the value of $c + d$ is _____

Q.6 The value of the limit

$$\lim_{x \rightarrow \frac{\pi}{2}} \frac{4\sqrt{2}(\sin 3x + \sin x)}{\left(2 \sin 2x \sin \frac{3x}{2} + \cos \frac{5x}{2}\right) - \left(\sqrt{2} + \sqrt{2} \cos 2x + \cos \frac{3x}{2}\right)}$$

is _____

SECTION 2 (Maximum Marks: 24)

- This section contains **SIX (06)** questions.
- Each question has **FOUR** options. **ONE OR MORE THAN ONE** of these four option(s) is(are) correct answer(s).
- For each question, choose the option(s) corresponding to (all) the correct answer(s).
- Answer to each question will be evaluated according to the following marking scheme:

<i>Full Marks</i>	:	+4	If only (all) the correct option(s) is(are) chosen;
<i>Partial Marks</i>	:	+3	If all the four options are correct but ONLY three options are chosen;
<i>Partial Marks</i>	:	+2	If three or more options are correct but ONLY two options are chosen, both of which are correct;
<i>Partial Marks</i>	:	+1	If two or more options are correct but ONLY one option is chosen and it is a correct option;
<i>Zero Marks</i>	:	0	If none of the options is chosen (i.e. the question is unanswered);
<i>Negative Marks</i>	:	-2	In all other cases.

- Q.7 Let b be a nonzero real number. Suppose $f: \mathbb{R} \rightarrow \mathbb{R}$ is a differentiable function such that $f(0) = 1$. If the derivative f' of f satisfies the equation

$$f'(x) = \frac{f(x)}{b^2 + x^2}$$

for all $x \in \mathbb{R}$, then which of the following statements is/are TRUE?

- (A) If $b > 0$, then f is an increasing function
- (B) If $b < 0$, then f is a decreasing function
- (C) $f(x)f(-x) = 1$ for all $x \in \mathbb{R}$
- (D) $f(x) - f(-x) = 0$ for all $x \in \mathbb{R}$
- Q.8 Let a and b be positive real numbers such that $a > 1$ and $b < a$. Let P be a point in the first quadrant that lies on the hyperbola $\frac{x^2}{a^2} - \frac{y^2}{b^2} = 1$. Suppose the tangent to the hyperbola at P passes through the point $(1, 0)$, and suppose the normal to the hyperbola at P cuts off equal intercepts on the coordinate axes. Let Δ denote the area of the triangle formed by the tangent at P , the normal at P and the x -axis. If e denotes the eccentricity of the hyperbola, then which of the following statements is/are TRUE?

- (A) $1 < e < \sqrt{2}$ (B) $\sqrt{2} < e < 2$ (C) $\Delta = a^4$ (D) $\Delta = b^4$

Q.9 Let $f: \mathbb{R} \rightarrow \mathbb{R}$ and $g: \mathbb{R} \rightarrow \mathbb{R}$ be functions satisfying

$$f(x + y) = f(x) + f(y) + f(x)f(y) \quad \text{and} \quad f(x) = xg(x)$$

for all $x, y \in \mathbb{R}$. If $\lim_{x \rightarrow 0} g(x) = 1$, then which of the following statements is/are TRUE?

- (A) f is differentiable at every $x \in \mathbb{R}$
- (B) If $g(0) = 1$, then g is differentiable at every $x \in \mathbb{R}$
- (C) The derivative $f'(1)$ is equal to 1
- (D) The derivative $f'(0)$ is equal to 1

Q.10 Let $\alpha, \beta, \gamma, \delta$ be real numbers such that $\alpha^2 + \beta^2 + \gamma^2 \neq 0$ and $\alpha + \gamma = 1$. Suppose the point $(3, 2, -1)$ is the mirror image of the point $(1, 0, -1)$ with respect to the plane $\alpha x + \beta y + \gamma z = \delta$. Then which of the following statements is/are TRUE?

- (A) $\alpha + \beta = 2$
- (B) $\delta - \gamma = 3$
- (C) $\delta + \beta = 4$
- (D) $\alpha + \beta + \gamma = \delta$

Q.11 Let a and b be positive real numbers. Suppose $\overrightarrow{PQ} = a\hat{i} + b\hat{j}$ and $\overrightarrow{PS} = a\hat{i} - b\hat{j}$ are adjacent sides of a parallelogram $PQRS$. Let \vec{u} and \vec{v} be the projection vectors of $\vec{w} = \hat{i} + \hat{j}$ along \overrightarrow{PQ} and \overrightarrow{PS} , respectively. If $|\vec{u}| + |\vec{v}| = |\vec{w}|$ and if the area of the parallelogram $PQRS$ is 8, then which of the following statements is/are TRUE?

- (A) $a + b = 4$
- (B) $a - b = 2$
- (C) The length of the diagonal PR of the parallelogram $PQRS$ is 4
- (D) \vec{w} is an angle bisector of the vectors \overrightarrow{PQ} and \overrightarrow{PS}

Q.12 For nonnegative integers s and r , let

$$\binom{s}{r} = \begin{cases} \frac{s!}{r! (s-r)!} & \text{if } r \leq s, \\ 0 & \text{if } r > s. \end{cases}$$

For positive integers m and n , let

$$g(m, n) = \sum_{p=0}^{m+n} \frac{f(m, n, p)}{\binom{n+p}{p}}$$

where for any nonnegative integer p ,

$$f(m, n, p) = \sum_{i=0}^p \binom{m}{i} \binom{n+i}{p} \binom{p+n}{p-i}.$$

Then which of the following statements is/are TRUE?

- (A) $g(m, n) = g(n, m)$ for all positive integers m, n
- (B) $g(m, n+1) = g(m+1, n)$ for all positive integers m, n
- (C) $g(2m, 2n) = 2g(m, n)$ for all positive integers m, n
- (D) $g(2m, 2n) = (g(m, n))^2$ for all positive integers m, n

SECTION 3 (Maximum Marks: 24)

- This section contains **SIX (06)** questions. The answer to each question is a **NUMERICAL VALUE**.
- For each question, enter the correct numerical value of the answer using the mouse and the on-screen virtual numeric keypad in the place designated to enter the answer. If the numerical value has more than two decimal places, **truncate/round-off** the value to **TWO** decimal places.
- Answer to each question will be evaluated according to the following marking scheme:
Full Marks : +4 If **ONLY** the correct numerical value is entered;
Zero Marks : 0 In all other cases.

Q.13 An engineer is required to visit a factory for exactly four days during the first 15 days of every month and it is mandatory that **no** two visits take place on consecutive days. Then the number of all possible ways in which such visits to the factory can be made by the engineer during 1-15 June 2021 is _____

Q.14 In a hotel, four rooms are available. Six persons are to be accommodated in these four rooms in such a way that each of these rooms contains at least one person and at most two persons. Then the number of all possible ways in which this can be done is _____

Q.15 Two fair dice, each with faces numbered 1, 2, 3, 4, 5 and 6, are rolled together and the sum of the numbers on the faces is observed. This process is repeated till the sum is either a prime number or a perfect square. Suppose the sum turns out to be a perfect square before it turns out to be a prime number. If p is the probability that this perfect square is an odd number, then the value of $14p$ is _____

Q.16 Let the function $f: [0, 1] \rightarrow \mathbb{R}$ be defined by

$$f(x) = \frac{4^x}{4^x + 2}.$$

Then the value of

$$f\left(\frac{1}{40}\right) + f\left(\frac{2}{40}\right) + f\left(\frac{3}{40}\right) + \cdots + f\left(\frac{39}{40}\right) - f\left(\frac{1}{2}\right)$$

is _____

Q.17 Let $f: \mathbb{R} \rightarrow \mathbb{R}$ be a differentiable function such that its derivative f' is continuous and $f(\pi) = -6$. If $F: [0, \pi] \rightarrow \mathbb{R}$ is defined by $F(x) = \int_0^x f(t) dt$, and if

$$\int_0^\pi (f'(x) + F(x)) \cos x \, dx = 2,$$

then the value of $f(0)$ is _____

Q.18 Let the function $f: (0, \pi) \rightarrow \mathbb{R}$ be defined by

$$f(\theta) = (\sin \theta + \cos \theta)^2 + (\sin \theta - \cos \theta)^4.$$

Suppose the function f has a local minimum at θ precisely when $\theta \in \{\lambda_1\pi, \dots, \lambda_r\pi\}$, where $0 < \lambda_1 < \dots < \lambda_r < 1$. Then the value of $\lambda_1 + \dots + \lambda_r$ is _____

END OF THE QUESTION PAPER

www.eenadupratibha.net